

IN THIS  
ISSUE:

WHAT IS AHEAD IN ELECTRONICS? BY DR. LEE DE FOREST

RADIO'S GREATEST MAGAZINE

# RADIO-CRAFT

Incorporating

**RADIO &  
TELEVISION**

HUGO GERNSBACK, Editor



SEE PAGE  
201



MANY ARTICLES  
FOR THE  
**RADIO  
BEGINNER**

JANUARY

**25¢**

CANADA 30¢

1943

OVER 100 ILLUSTRATIONS

# TRIPPLETT

## NEW *Combat Line* INSTRUMENTS

THESE PHOTOGRAPHIC REPRODUCTIONS ARE THREE-QUARTER SIZE

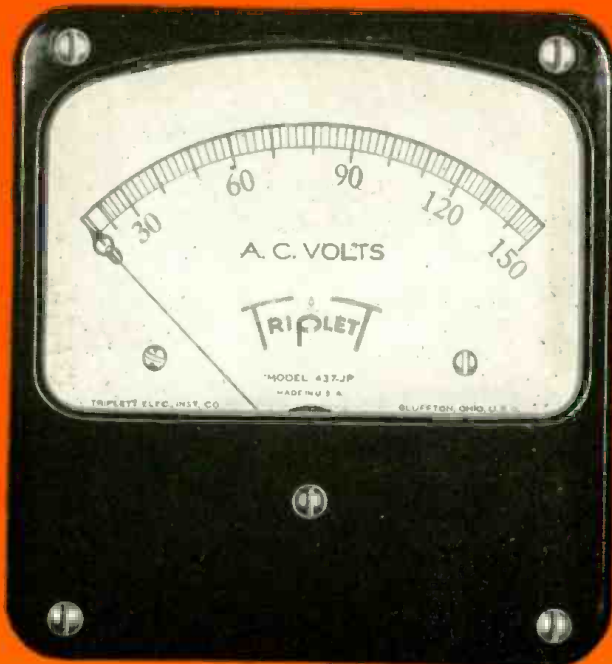

MODEL 437-JP

MODEL 372

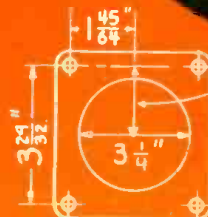

Model 437 - J P



Model 372

SIMPLE  
INSTALLATION  
DIAGRAMS

Maximum Service in Minimum Space

### TRIPPLETT *Thin Line* INSTRUMENTS

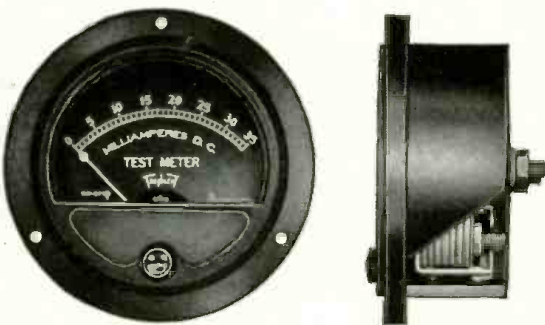

Precision performance by new *thin* instrument with *standard* Triplet movement housed in either metal or molded case. No projecting base; wider shroud to strengthen face; simplified zero adjustment; balanced bridge support; metal bridges at both ends; doubly supported core. For "Precision in limited space" write for Triplet Thin Line Bulletin.

## The Triplet Combat Line

New Answers to specialized needs of War: Production Speed-up and Standardization; Performance under the Stress and Vibrations of Combat Service.

Model 437 J P—A rectangular line of meters to meet dimensions shown (see diagram). Wide-open scale for maximum readability. Complete coverage AC-DC Voltmeters, Ammeters and Wattmeters. Magnetic or static shielding provided on order. Molded Plastic Case for maximum protection in high voltage circuits. Pivots, Jewels and other component parts designed to meet severe vibration requirements.

Model 372—Frequency Meter—"All-American make" Vibrating Reed Frequency Meter. Maximum readability by grouping of Reeds. Range-Frequency-Voltage to meet specific requirements. Protected against excessive panel vibration. In standard 3 inch mounting or on special order in any cataloged Triplet Case.

### A WORD ABOUT DELIVERIES

Naturally deliveries are subject to necessary priority regulations. We urge prompt filing of orders for delivery as may be consistent with America's War effort.

TRIPPLETT ELECTRICAL INSTRUMENT CO.  
BLUFFTON, OHIO





I. E. SMITH  
President  
National Radio  
Institute  
Established  
28 Years

# I WILL TRAIN YOU TO START A SPARE TIME OR FULL TIME RADIO SERVICE BUSINESS WITHOUT CAPITAL

**N. R. I. MEN  
WORK IN THESE  
BRANCHES, TOO**



(Above) BROADCASTING STATIONS employ Radio Technicians, Operators for installation, operation, maintenance work, at good wages.

(Above) RADIO SHOPS, DEALERS, JOBBERS employ Radio Technicians in steady, interesting jobs at good pay.



(Above) GOVERNMENT and Shipping Companies give good jobs to Radio Operators. (Left) POLICE AND COMMERCIAL AVIATION are active Radio fields. N.R.I. gives the Radio knowledge they require.

**EXTRA PAY IN  
ARMY, NAVY, TOO**

Men likely to go into military service, soldiers, sailors, marines, should mail the coupon now! Learning Radio helps men get extra rank, extra prestige, more interesting duties. MUCH HIGHER PAY. Also prepares for good Radio jobs after service ends. Hundreds of service men now enrolled.

## FREE TRIAL LESSON

I will send you FREE a Sample Lesson, "Getting Acquainted with Receiver Servicing," to show you how practical it is to train for a good-pay Radio job at home in spare time. It's a valuable lesson. Study it—keep it—without any obligation whatsoever. Tells how to fix—without any work—why Radio Tubes fall—how to fix dyne Receivers work—why Radio Output Transformers—Electrodynamo Loudspeakers and Gives hints on I.F. how Gang Tuning Condensers work—defective soldered joints—Transformer Repair—how to locate defective Servicing Tech—Antenna, Oscillator Coil facts—Receiver Servicing Techniques—dozens of other hints, facts, explanations. Illustrated with 31 photos, sketches, drawings. Get your copy at once—mail the coupon NOW!

**Mail Now**

I Trained These Men

### These Men Have SPARE TIME BUSINESSES



"I repaired some Radio sets when I was on my tenth lesson. I really don't see how you can give so much for such a small amount of money. I made \$600 in a year and half. I have made an average of \$10 a week—just spare time." JOHN JERRY, 1337 Kalamath St., Denver, Colorado.

"I do Radio Service work in my spare time only, operating from my home, and I net about \$40 a month. I was able to start servicing Radios 3 months after enrolling with N.R.I." WM. J. CHERMAK, R. No. 1, Box 287, Hopkins, Minn.



"I am doing spare time Radio work, and I am averaging around \$500 a year. Those extra dollars mean so much—the difference between just barely getting by and living comfortably." JOHN WASHIKO, 97 New Cranberry, Hazleton, Penna.

I Trained These Men

### These Men Have FULL TIME BUSINESSES



"For several years I have been in business for myself making around \$200 a month. Business has steadily increased. I have N.R.I. to thank for my start in this field." ARLIE J. FROEINER, 300 W. Texas Ave., Goose Creek, Texas.

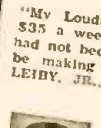

"My Loudspeaker System pays me about \$35 a week besides my Radio work. If it had not been for your Course I would still be making common wages." MILTON K. LEIBY, JR., Tooton, Pa.



"I started Radio in the Marines in 1917. I also built sets in the early days of N.R.I. for a living. I recommend N.R.I. Training to any man no matter how long he has worked in Radio. I now have my own business." CHARLES F. HELMUTH, 16 Hobart Ave., Absecon, N. J.

Now is the time to get ahead—in RADIO! The wartime shortage of Radio Technicians and Operators gives you a great opportunity to open your own Radio Business, or to go after a good Radio job with a bright peacetime future. Start at once. MAIL THE COUPON for a FREE Lesson from my Radio Course, plus my big, 64-page book, "Rich Rewards in Radio." See for yourself how I will train you in spare time to be a Radio Technician or Operator!

You'll read how my Course can help you—just as it helped the six men above—to start your own Radio business on money you make while learning—you'll see how N.R.I. also prepares you for a good job in many of Radio's profitable branches—Broadcasting, Radio Manufacturing, Public Address System, Aviation, Police, Commercial Radio, etc. MAIL THE COUPON NOW!

**How the "N. R. I. Method" Helps  
Many Win Jobs Paying \$30,  
\$40, \$50 a Week**

The up-to-the-minute Radio Technician or Operator must have BOTH theoretical knowledge and a practical understanding of how to apply Radio principles. I give you thorough training in Radio Theory—show you how to use your knowledge. N.R.I. trains you "from the ground up"—covers every fundamental: Radio Terms, Symbols, Diagrams; Receiver Troubles, Servicing; Television; FM Receivers, Transmitters; Cathode Ray Oscilloscopes; Electronic Controls, etc. These are just a FEW of the subjects you'll cover before you finish my Course!

### Beginners Quickly Learn to Make \$5, \$10 a Week in Spare Time

Many N.R.I. students make \$5, \$10 a week extra money fixing Radios in spare time while still learning. I send EXTRA MONEY JOB SHEETS that tell how to do it. Many N.R.I. graduates start their own full time Radio businesses. Others take interesting jobs with Broadcasting Stations, Radio Manufacturers, rushing to fill Government orders, need more trained men. Radio Technicians and Operators are needed for good Civilian jobs with the U. S. Government, Aviation, Police, Commercial Radio and Public Address Systems need trained Radio men. And think of the NEW Radio Jobs that Television, Frequency Modulation, and Electronics will open after the war! I give you the Radio knowledge required for these jobs.

### Let This Great Organization Help You

Throughout your training, the staff and resources of the world's largest institution devoted to training men for Radio will be squarely behind you. N.R.I. has stuck to the one job of teaching Radio for 28 years. My entire staff of more than 100 people devotes full time to Radio training. Our combined efforts have made the Course so interesting, with hundreds of pictures, charts, and diagrams—so easy-to-grasp, with special teaching methods designed especially for home training—that we believe you will be "old friends" with Radio almost before you know it.

### Start NOW -- Mail Coupon for FREE LESSON and Book

MAIL THE COUPON—I'll send you the FREE lesson and my 64-page illustrated book, RICH REWARDS IN RADIO. No obligation. You'll see what Radio offers YOU. And you'll have my FREE lesson to keep. No salesman will call. Just MAIL THE COUPON NOW!—J. E. Smith, President, National Radio Institute, Dept. 3AX, Washington, D. C.

## TRAINING MEN FOR VITAL RADIO JOBS

**GOOD FOR BOTH** 64 PAGE BOOK **FREE** SAMPLE LESSON

J. E. SMITH, President, Dept. 3AX  
National Radio Institute, Washington, D. C.

Without obligating me, mail your Sample Lesson and 64-page book FREE. I am particularly interested in the branch of Radio checked below. (No salesman will call. Write plainly.)

- |  |  |
|--|--|
| <input type="checkbox"/> Radio Service Business of My Own                  | <input type="checkbox"/> Aviation Radio                  |
| <input type="checkbox"/> Service Technician for Radio Stores and Factories | <input type="checkbox"/> Operating Broadcasting Stations |
| <input type="checkbox"/> Spare Time Radio Servicing                        | <input type="checkbox"/> Army, Navy Radio Jobs           |
| <input type="checkbox"/> Auto Radio Technician                             | <input type="checkbox"/> Operating Police Radio Stations |
|  | <input type="checkbox"/> Operating Ship and Harbor Radio |

(If you have not decided which branch you prefer—mail coupon for facts to help you decide.)

Name .....

Address .....

City .....

State .....

Age .....

4FR-2





# RADIO-CRAFT

Incorporating

**RADIO & TELEVISION**

**HUGO GERNSBACK**  
Editor-in-Chief

**KARL E. SCHUBEL**  
Associate Editor

**FRED SHUNAMAN,**  
Technical Editor

**G. ALIQUO**  
Circulation Manager

Contents **JANUARY, 1943** Issue

**VOLUME XIV -- NUMBER 4**

Mailbag .....	196
Editorial: The Post-War Radio Receiver... by Hugo Gernsback	199
The Radio Month in Review.....	200

## ELECTRONICS

What Is Ahead in Electronics? by Dr. Lee DeForest, Ph.D.; S.C.D.; D.Eng.	202
Optics and Electronics..... by John R. Kearney	204
New Electron Microscope .....	206
A Versatile Square Wave & Pulse Generator... by Warren Miller	207
Radio Frequencies Speed Tin Plating .....	208
The Electronic Cop .....	208
A New Frequency Divider for Obtaining Reference Frequencies .....	by F. R. Stansel 209

## TEST INSTRUMENTS

A Simplified Electronic Voltmeter, Part I..... by Harold Davis	210
--	-----

## RADIO INSTRUCTION

New York State Signal Corps School .....	211
--	-----

## SERVICING

<b>RADIO SERVICE DATA SHEET:</b> No. 329 Westinghouse Radio Model WR-290 .....	212
---	-----

## SOUND

How to Hook Up Radio Record Players... by Joseph A. Inness	214
I-Tube Interphone on A.C.-D.C..... by Arthur Blumenfeld	216
Audio Scale for Blind .....	218
Remote Mixer .....	219

## EXPERIMENTERS

The "Simplicity-1" .....	by H. Gernsback 220
Constructing the "Simplicity-1".....	by Fred Shunaman 222
Portable Receiver Power Packs.....	by Fred Shunaman 224

### IN THE NEXT ISSUE

The February issue will contain the following:

- Today & Tomorrow in Electronics
- Lenz' Law in Modern Speech
- A Real Phono Oscillator and a further selection of articles for the
- **RADIO BEGINNER**

## BEGINNERS

How Signals Are Sent.....	by C. W. Palmer 229
I-Tube All Wave Battery Set.....	by W. Green 230
Microphones Explained for the Beginner .....	231
Servicing A.C.-D.C. Midgets for Beginners .....	232

## CONSTRUCTION

How to Make A Good Antenna .. by Franklin Williams, W6ULE	246
A Tiny P.A. Amplifier .....	246

## DEPARTMENTS

Mailbag .....	196
The Radio Month in Review .....	200
RADIO SERVICE DATA SHEET (See Servicing) .....	212
Latest Radio Apparatus .....	226
Question Box .....	236
Radio Hookups .....	238, 244
Radio Kinks .....	245, 250
Servicing Notes .....	253
Book Reviews .....	255



Published by Radcraft Publications, Inc. Publication office: 29 Worthington Street, Springfield, Mass. Editorial and Advertising Offices: 25 West Broadway, New York City. Chicago Advertising Office: RADIO-CRAFT, 520 North Michigan Avenue, Chicago, Ill.

RADIO-CRAFT is published monthly, on the first of the month preceding that of date; subscription price is \$2.50 per year in U. S. (In foreign countries, 75c additional per year to cover postage; Canada, 50c additional.) Entered at the post office at Springfield as second-class matter under the act of March 3, 1879. All communications about subscriptions should be addressed to: Radio-Craft, 25 West Broadway, New York, N. Y.



Foreign Agents:

London—Gorrings's American News Agency, 9A Green St., Leicester Square, W. C. 2, England.  
Melbourne—McGill's Agency, 179 Elizabeth St., Australia.  
Dunedin—James Johnston, Ltd., New Zealand.



Text and illustrations of this magazine are copyright and must not be reproduced without permission of the copyright owners.



Copyright 1943 Radcraft Publications, Inc.

# WATCH ★ ★ ★ ★ MIDWEST

AFTER THE WAR IS WON ★ ★ ★  
FOR SENSATIONAL ADVANCEMENTS  
AND FEATURES SUCH AS - - -

**SUPER BAND - SPREAD TUNING\***

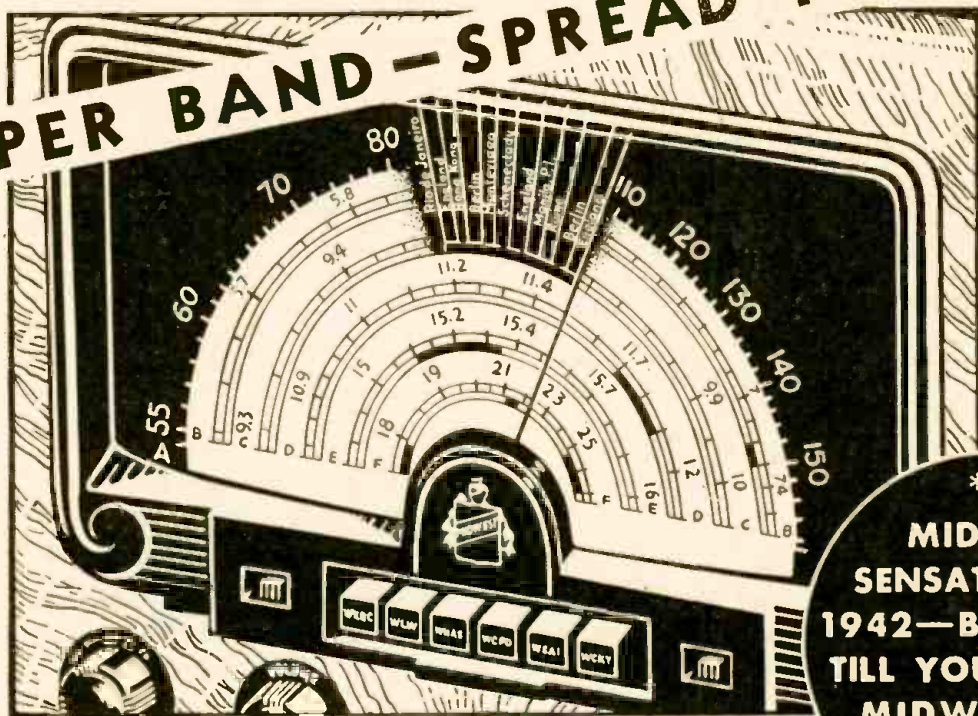

**\*A  
MIDWEST  
SENSATION IN  
1942—BUT WAIT  
TILL YOU SEE THE  
MIDWEST OF  
TOMORROW**

OUR ENTIRE PRODUCTION FACILITIES  
ARE NOW DEVOTED TO MANUFACTURING  
RADIO EQUIPMENT FOR OUR ARMED FORCES  
**BUT...WHEN VICTORY IS WON**

**YOU'LL BE BUYING YOUR MIDWEST RADIO  
DIRECT FROM THE FACTORY**

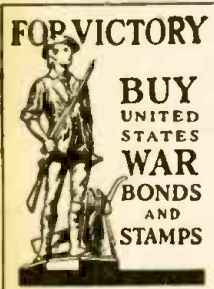

SAVING UP TO **50%**  
WILL BE JUST AS POPULAR AS EVER

Yes, Sir. Thousands upon thousands of people all over the U. S. were buying super powerful Midwest Radios direct from our factory until "Pearl Harbor" and if the many letters we are still receiving every day is an indication, the direct-to-user-plan will be more popular than ever after the War is won.

**FREE** 

FOR A LIMITED TIME ONLY

A beautiful 12" x 8" "Old Glory" Calendar in full colors absolutely free if you send 10 cents for a U. S. War Savings Stamp. Just send a dime or 10¢ in postage stamps and your Calendar and War Savings Stamp will be sent promptly.

**MIDWEST RADIO CORPORATION**  
**DEPT. 12-A** **CINCINNATI, OHIO**



**Centralized Service on everything in Radio and Electronics**

Reach for your ALLIED Catalog...

Get Everything in Radio and Electronics from this one central arsenal of supply—over 15,000 items for the Armed Forces, for Radio Training, for Research Laboratories, for War Industries, and for Service Replacement. Our large complete stocks speed delivery. Our experienced staff can help you. Send for your Free Allied Buying Guide.

Send for the New ALLIED'S Radio-Formula and Data Book

For Radio Students, Instructors, Technicians, Engineers. Contains valuable Formulas, Tables, Data and Standards commonly used in Radio and Electronics. 10c

ALLIED RADIO CORP.  
833 W. Jackson Blvd., Dept. 2-A-3, Chicago

**ALLIED RADIO**

**A "LAB" to fit your pocket**



MODEL 739

\$10.89

Dealer Net Price

**A.C. D.C. VOLT-OHM-MILLIAMMETER**

Pocket Volt-Ohm-Milliammeter with Selector Switch Molded Case. Precision 3-inch Meter with 2 Genuine Sapphire Jewel Bearings. AC and DC Volts 0-15-150-750-1500; DC MA. 0-1-15-150; High and Low Ohm Scales. Dealer Net Price, including all accessories, \$10.89. MODEL 739 . . . DC Pocket Volt-Ohm-Milliammeter. Dealer Net Price . . . \$8.25

WRITE FOR CATALOG

SECTION 717 COLLEGE DRIVE

READRITE METER WORKS, Bluffton, Ohio

**DISCUSSES ARTICLES**

Dear Editor:

As a regular reader of *Radio-Craft*, I have picked up a number of tricks that are quite a help at times. To get the best out of each issue I have to read from cover to cover because I can never tell where I might find something useful.

In many of the articles the writer, in my estimation, does not go far enough. In these times of priorities and lack of radio men, there are many newcomers to the field who are not thoroughly acquainted with all the intricacies to be encountered.

All this discourse is brought out by two articles. On page 125 of the *November* issue there is a short article by *Thomas D. Bigelow*. Now the idea is quite all right but don't you think that Mr. Bigelow should be asked to elaborate a little. For instance, there should be a condenser in series with the phones in his push-pull diagram. It is well known that in the winding of the commercial transformers used in receiving sets, the D.C. resistance of the two halves of the transformer primary varies. This creates a difference of potential between the two plates and if the service man is using a pair of crystal phones, well you know the answer.

There are other discrepancies involving impedances but I don't think we need go into that other than to say that sometimes the quality might not be up to par.

Another article is that by *Wm. G. Lof-*

*strom* on page 22 of the *October* issue. This article has proven quite popular in this part of the country but I think Mr. Lofstrom should have taken care of the problem of using meters which are not sufficiently damped to prevent too great overswing.

If the service man likes to use a scale where the readings are close to the maximum point of the scale and using a meter with no damping, in time it will injure the meter. The insertion of a resistance in series with the meter and shunted by a momentary contact switch of the push-button or toggle type will protect the meter against this trouble. The value of the resistance should be such that with the resistance in the circuit, the meter will read about 75% of the actual wattage then when the resistor is shorted the meter will swing gently to the point of actual value.

Well I guess that gets everything off my chest.

By the way, how about getting *Radio-Craft* when one is in the army? I expect to be there soon.

DAVID LEBARRE  
Detroit, Mich.

(D.C. variations in primary have no effect on secondary, but A.C. variations do. When using crystal phones it is always advisable to put a volume control in series with it.—*Editor*)

**HELPS BEGINNERS**

Dear Editor:

I would like to thank you for the "Gernsback Educational Library." Recently a scout leader asked me to teach some of the boys enough about radio to enable them to get merit badges, and I was swamped until I thought of your books. The kids "ate 'em up" and our town has a whole new crop of budding "super-bloopers" (and De-Forests, I hope.)

I depleted my junk box building three-tube A.C.-D.C. shortwave sets for them. A lot of them wanted B.C.L. coils, but I told them the first time I found them connecting a regenerative set that tuned above 160 meters to an aerial it was curtains for the whole program.

Most of the kids wanted bread-board models, with all the works out in the open to be admired, and we were going broke buying top-of-panel mount sockets until I thought of using wafer sockets, with 1/2-inch brass spacers to raise them up for base-board wiring.

I laid in a gross of Fahstock clips and plenty of soldering lugs and short wood screws, and now we're in mass production.

I also use 40-lamps in series with the 0.3 amp. tubes to drop the voltage for the heaters, its cheaper than 50-watt resistors

or line cord resistors and involves no calculations. I've connected two 76's, three 76's, or a 6D6, 43 and 25Z5 up, and using the 40-watt lamp series arrangement with equally good results.

I find that for a beginner with little money to spend on radio, the A.C.-D.C. circuit is best in the long run; batteries come high.

Hum is sometimes a little bad with phones, but I have thought of a solution. How about hooking up a 6SK7 and 6SJ7 in parallel, then wiring them in series to a 25L6 A.F. amplifier and 25Z5 rectifier? The 0.15 amp. tubes in parallel should work in a series arrangement with the 0.3 amp. heaters, and the tubes which are most critical to hum would be at ground potential.

I'll try it as soon as I can gaff a couple of the 0.15 amp. tubes.

NEIL EPLIN,  
Alberton, Mont.

(We are glad Mr. Eplin found the Gernsback Educational Library of such great help. It has helped thousands.)

His idea to reduce hum sounds interesting, and ought to work out, if chassis is connected through a condenser to a good ground.—*Editor*)

**SIGNAL TRACER WORKS FINE**

Dear Editor:

With reference to Mr. Olson's article in a previous issue, presenting the project of a signal tracer, I would like to say that I have made such a device myself with good results.

As I considered it more practical, the outfit was built in a large ex-tester box which I bought for the purpose, and I have now to complete a tester which will work in the same box alongside the former, but in this country there is a very great shortage of milliammeters so that I will have to wait until the war is over.

I am a native of Argentina and really deplore the present situation in radio as now I am not in a position to hear any more of my brothers' amateur transmissions from U.S.A.

However, I do not think this will last long and soon things will return to normal.

By the way I would like to exchange correspondence with any radio-fan or service-man.

ARNALDO E. ROBERT,  
Onativo 4563,  
LANUS, F.C.S.,  
ARGENTINA.



**LIKES CIRCUIT DIAGRAMS**

Dear Editor:

I have been a steady subscriber to your magazines for the past four years. These magazines have been read many, many times.

This year I purchased a large looseleaf "radio scrapbook" and pasted in all diagrams of interest to me. Looking over the scrapbook there is no doubt that the chief diagrams are of amplifiers. At this time transformerless ones are of special importance.

The scrapbook is also strong on T.R.F. circuits and devoid of television and "ham" articles.

Many times I have seen only one diagram of interest to me in a magazine, but felt it worth the thirty cents.

It makes me smile to see a diagram using a two cent resistor instead of a ninety cent choke which would cost us Canadians \$4.50 and which at the present time is unobtainable.

I would appreciate seeing a diagram of a three-stage T.R.F. tuner, preferably 6SK7, 6SK7, 6SJ7 or 6C5.

So—more circuit diagrams, please!

GILBERT MILLER,  
Toronto, Canada.

(We are glad Mr. Miller likes the diagrams, and regret that due to the war, circuits on television and ham rig are unavailable or are obsolescent. We look forward to a tremendous return to this type of data when the victory is won. As for the T.R.F. tuner, a future issue will give information on this.—Editor)

**WANTS EXPERIMENTAL ARTICLES**

Dear Editor:

One reason why *Radio-Craft* is the best radio magazine is because of its many interesting features.

Of main interest to me are the Experimental Departments and the Mailbag section. I would like more articles on experimental effects and especially on communication by induction.

MELVIN SMITH,  
Los Angeles, Calif.

(We are glad Mr. Smith likes our magazine. We expect to have articles on experimental effects, communication by induction for example, real soon.—Editor)

**LIKES FILM RECORDING**

Dear Editor:

An article written by H. W. Knettel in *Radio-Craft* Magazine interested me tremendously.

The article entitled "Wide Range Film Recording for Home Use" at once aroused (up till now) "sleeping" interest in sound reproduction: "sleeping interest" brought on by current events!

However being a former sound man and amateur home recordist, and that coupled with the simple fact that I love music of every type, naturally I'm vitally interested in any and every advance in sound reproduction.

Can you give me any further information on this new instrument direct from the manufacturer?

I would appreciate it if I might learn a bit more about it.

DAN H. OHLSON,  
(No address given)

(Ozalid Products Division at Johnson City, N. Y. should be able to give Mr. Ohlson the required information.—Editor)

**INTERESTED IN AUDIO DATA**

Dear Editor:

In the October issue of *Radio-Craft* there is an article by Fred Shunaman entitled "Practical Transformer Design" which was very interesting, instructive and valuable. This is especially so at the present time because certain types of transformers are unobtainable without a priority and no household radio service man can obtain one.

For this reason I look forward to having to rewind some when the set is worth it and the owner is willing to pay the cost. Wire of the sizes and quantity needed will be a bottleneck although I happen to have a small quantity.

At the end of the article the author states that in the event that the readers of *Radio-Craft* would be interested in a future article on output and audio transformers, it will be printed. Practically no articles have been published on this subject to my knowledge and I believe it would be of a great deal of interest and value. Please consider it seriously.

Another article which I believe would be of interest and value is an A.C.-D.C. V.T.V.M. and ohmmeter such as RCA's voltohmyst. But sensitive microammeters such as are used in the RCA arrangement are not only unobtainable, but are not in the serviceman's possession. So, while I have not gotten around to it as yet and the way work is now, may not get the time, still I wish to do it. That is, to utilize a direct-coupled amplifier similar to the audio amplifiers you have published articles about.

It would appear as if an 0-10 milliammeter could then be used and yet have the circuit sensitive without grid current flowing to render the low readings inaccurate.

A great many servicemen have basic milliammeters with scales of 0-1 and 0-10 milliamps.

C. D. HEWITT,  
Hamden, Conn.

(We plan to have something soon on audio frequency transformers, and later, something on vacuum tube voltmeters and ohmmeters.—Editor)

**SHORT WAVE FAN**

Dear Editor:

I just got acquainted with your magazine. In the June, 1940, edition I found a list of short wave stations which I found to be very good.

I am an ardent radio amateur, especially a DX fan. I saw the notice about a more complete list of short wave stations. I have a six tube set which I am using for DX work.

I'll be very appreciative of your cooperation to help me by sending me the short wave list.

ANTHONY LASKOWSKI,  
(No address)

(Since reader Laskowski gave no address we were unable to answer him. However it might be stated here that all lists of stations of course are now rendered obsolete by the war and will probably be revised when its over.—Editor)

**COOKE'S SLIDE RULE**

Dear Editor:

In the October issue of *Radio-Craft* I noticed an inquiry regarding the Cooke Radio Slide Rule.

This slide rule is listed in the Kenffel and Esser Company catalog but at present is a priority article and cannot be obtained without a preference rating.

NELSON M. COOKE,  
Lieut. (jg) USN  
Anacostia Station,  
Washington, D. C.



**CHECK HERE!**

... if you want a **BETTER** radio job!

Technical ability is the only thing that stands between you and a better job. . . .

• Face the facts! Present-day conditions which surround employment and promotion in all branches of both civilian and military radio are actually unbelievable. The tremendously expanded demand for technically trained radiomen has created a condition wherein there are many more jobs than qualified men to fill them.

• Hundreds of men have had new jobs at comparatively high pay literally thrust upon them. Manufacturers are offering increased base pay to attract new additions to their staffs.

• If you have a commonplace job—a temporary job. If you are a "ham" who would like to make your avocation your vocation—if you have the ambition to hold a position of greater responsibility with higher pay . . . then enrolling for, and completing a CREI home study course in Practical Radio Engineering is the most important thing you can do toward accomplishing your ambition at this most opportune time.

**• WRITE FOR FREE 32-PAGE BOOKLET**

If you have had professional or amateur radio experience and want to make more money—let us prove to you we have something you need to qualify for a better radio job. To help us intelligently answer your inquiry—please state briefly your background of experience, education and present position.



**CREI Students and Graduates — ATTENTION!**

The CREI Placement Bureau is flooded with requests for CREI trained radiomen. Employers in all branches of radio want trained men. Your government wants every man to perform his job, or be placed in a job, that will allow him to work at maximum productivity. If you are or will be in need of re-employment write your CREI Placement Bureau at once.

**CAPITOL RADIO ENGINEERING INSTITUTE**

Home Study Courses in Practical Radio Engineering for Professional Self-Improvement

Dept. RC-1, 3224—16th Street, N. W. WASHINGTON, D. C.

Contractors to the U. S. Signal Corps—U. S. Coast Guard Producers of Well-trained Technical Radiomen for Industry

**absolutely FREE!**

**the AEROVOX**

**Research Worker**

• Yes, the Aerovox Research Worker can be mailed to you month after month, absolutely free! Chuckful of latest radio and electronic data, charts, formulae, diagrams, suggestions. Simply indispensable in your work.

• Ask local jobber about a free subscription. • Or write Aerovox Corporation, Dept. RN, New Bedford, Mass.



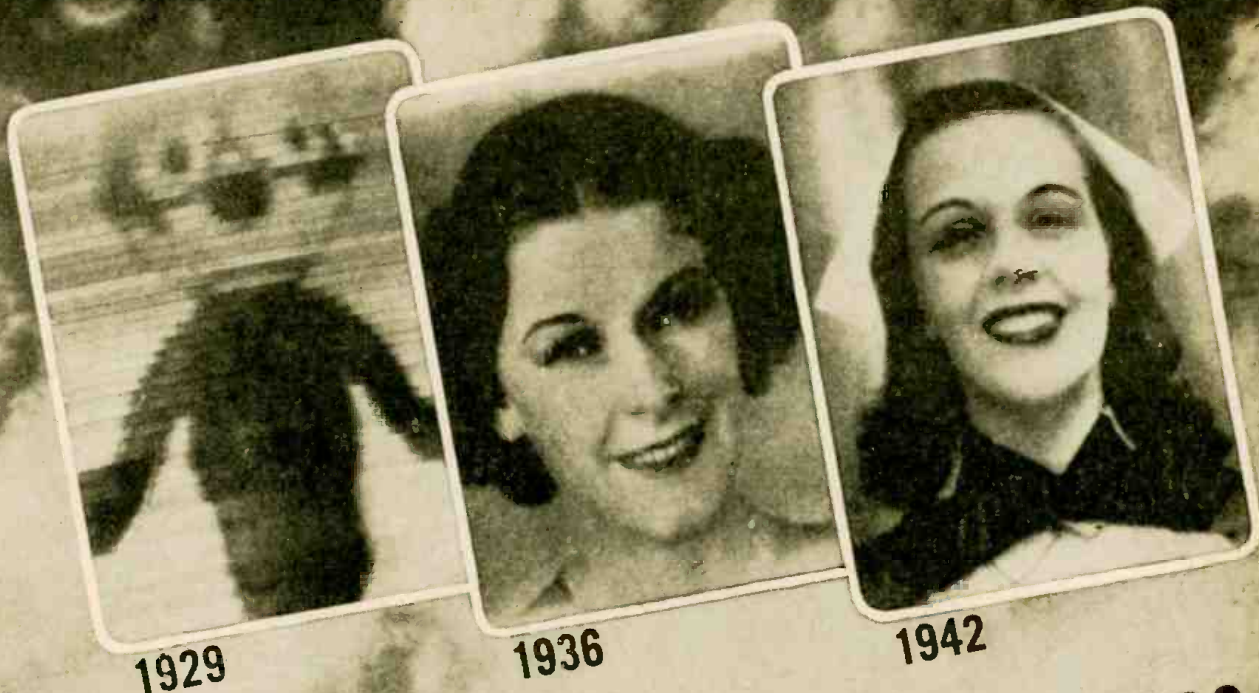

Unretouched pictures  
photographed directly  
from RCA television  
receiver screens.

## FROM TELEVISION'S ALBUM OF PROGRESS

Felix the Cat had a bewildered look on his face in 1929 when he swung around for hours on a phonograph turntable in front of television's early scanning disks. Felix's image was slashed into 60 horizontal lines—60 streaks of light and shade. Engineers of RCA watched the antics of Felix as he was tossed through space to receiving screens. They realized that all streaks and flicker must be removed.

Scientists of RCA Laboratories abandoned mechanical scanners and developed an all-electronic system of television, featuring the Iconoscope and Kinescope, electronic "eyes" of the radio camera and the receiving set. Motors and high-speed disks were eliminated both at transmitter and receiver. Electronic television became as quiet and fool-proof in operation as a home radio set.

By 1936, the number of lines per picture had been increased to 343, with marked improvement in quality. But the research men still were not satisfied. They

continued to experiment, and to develop new equipment, for finer pictures of 441 lines. Before Pearl Harbor, 525-line television pictures were on the air from the NBC station atop the Empire State Building.

The streaks had vanished. Television at last had the texture of rotogravure. Now, faces and scenes are photographed directly from television screens without betraying the presence of scanning lines.

Brought to life by electronic tubes, and given wing by radio, television emerged from RCA Laboratories to reveal its practical usefulness. Today, knowledge gained from years of television research is contributing vitally to the war effort.

Recognizing the importance of television as a post-war industry and useful public service, RCA is continually pioneering in the science of radio sight. Television's album of progress has only begun.



### RCA LABORATORIES

*A Service of Radio Corporation of America, RCA Building, New York*

**PIONEER IN RADIO, ELECTRONICS, TELEVISION**

*Other Services of RCA: RCA Manufacturing Co., Inc. • Radiomarine Corporation of America  
R.C.A. Communications, Inc. • National Broadcasting Co., Inc. • Blue Network Co., Inc. • RCA Institutes, Inc.*



# RADIO-CRAFT

Incorporating

RADIO & TELEVISION

"RADIO'S GREATEST MAGAZINE"

. . . *Post-war radio sets will be wholly different* . . .

## THE POST-WAR RADIO RECEIVER

By the Editor — HUGO GERNSBACK

**T**HE present war, which is changing everything on the face of this globe, will leave a strong imprint on post-war radio receivers. There will be revolutionary changes not only in radio sets, but in everything connected with radio.

By the time the war is over, the majority of radio receivers now in use will be hopelessly out-dated. Indeed, in a radio sense, they will be antiquated. Behind locked doors in our radio and research laboratories, there is tremendous activity today. Great advances and many new discoveries have been made in the radio and allied fields and the end is not in sight.

All authorities are agreed that right after the cessation of hostilities, Radio Broadcasting in the United States will swing almost immediately into FM (frequency modulation). If the war had not intervened in 1941, there would now be in operation many hundreds of FM transmitters throughout this country. Only the scarcity of materials and labor, as well as the necessities of war cut all FM expansion down to almost the zero point. Inasmuch as television is inexplicably linked with FM, there can be little question that frequency modulation will be the order of the day after the war.

War production, war fabrication and assembling technique will no doubt carry over when peace returns once more. For this reason, radio sets of the future will not only be constructed by entirely new methods, but the materials in these sets will vastly change, too.

Plastics, for instance, will be strongly represented in post-war sets. Ordinary wood and similar materials will almost disappear, except perhaps in the larger console sets—and even here it will be superseded by plastic-laminated wood which does not shrink nor warp; it is in some respects stronger than steel. When I say "plastics," I mean a variety of plastics. The pre-war plastic cabinet, for instance, is only one type. I just mentioned wood-plastics, but we also have today fabric-plastics—that is, fabrics impregnated with plastics; and the new paper-plastics—paper impregnated with plastics. So strong is this new substance that it is already being used in airplane wing-tips.

Manufactured radio sets will probably no longer have the hundreds of different soldered connections. Soon the soldered connection will be out-dated. We will have a good deal of instant-spot welding in most of the wire and other connections in radio sets. But I can foresee the day when even this will be outmoded. I can imagine commercial radio sets without a single soldered or welded connection. It is quite possible to do so and still have excellent electrical connections. Radio tubes, for instance, have never had soldered connections, because the tube must be taken out and replaced. It is conceivable that post-war receivers will have many of their components arranged in such a manner that each one can be taken out without unsoldering. We will have wires fabricated of tough metal, yet good conductors. Each one of these wires will have a mechanical connection at each end, which will make positive contact with other connectors or components.

Instead of having as many condensers and resistors as we have

today, radio circuits, due to a new variety of tubes, will be simplified to such an extent that all of the smaller condensers will be assembled in a single block, as will most of the resistors. We will have resistor blocks and condenser blocks to which all connections are made. These blocks will have the individual condensers or resistors, as the case may be, mechanically fitted in such a way, that each one can be pulled out and a new one inserted without any tools, yet the contacts will all be perfect.

All this will help tremendously not only in assembling the receivers but, more important, in servicing radio sets.

The major trouble with pre-war radio sets was, that it is often a hopeless job to try and find out what is wrong in a set and too much time is wasted in finding defective components.

I maintain that in the past, there has been entirely too much radio engineering and too little physics. May I recommend to the radio industry that the physicist has a tremendous job to perform in our post-war radios. All of our sets are much too complicated and they need to be simplified; in the process they will automatically become more efficient and better than ever before.

When I put such emphasis on physics, I say so for the following considerations:

There exists a tremendous amount of misinformation and blind groping in many phases of radio today. The old-time radio man, when he thinks back to the crystal days, will remember having heard reports of singing and talking water faucets, talking tea kettles and frying pans—in the vicinity of radio transmitters. These are important clues which have never been followed up by any physicist. Have you ever heard of the speaking and talking arc lamp? Did you know that an ordinary incandescent lamp can be made to emit music? Have you ever heard a talking transformer or a singing motor or dynamo? All of these things are well known in physics but the radio engineer has not worried his head about it. What I am trying to say is, that our present loud speakers are woefully inadequate and that the future sound reproducers, will bear no resemblance to our present inefficient types.

Physicists are well acquainted with molecular sound emission. The radio designer knows little about this. Finally, every scientist knows that the cricket is the most efficient sound machine known. By rubbing his legs against the wings, a relatively tremendous sound is generated—a feature which we never have seen remotely tried to reproduce or make use of.

You can hear a cricket on a clear night over a good distance. The power that is used to generate that sound is of astronomical minuteness when compared to the sound reproducers which we use in our radio sets today.

The post-war radio receiver will have many of the above features incorporated in it. Twenty years hence we will look with amusement upon pre-war radio receivers. They will make us laugh—the same as we laugh or smile at the old crystal receiver today.



## A Digest of News Events of Interest to the Radio Craftsman

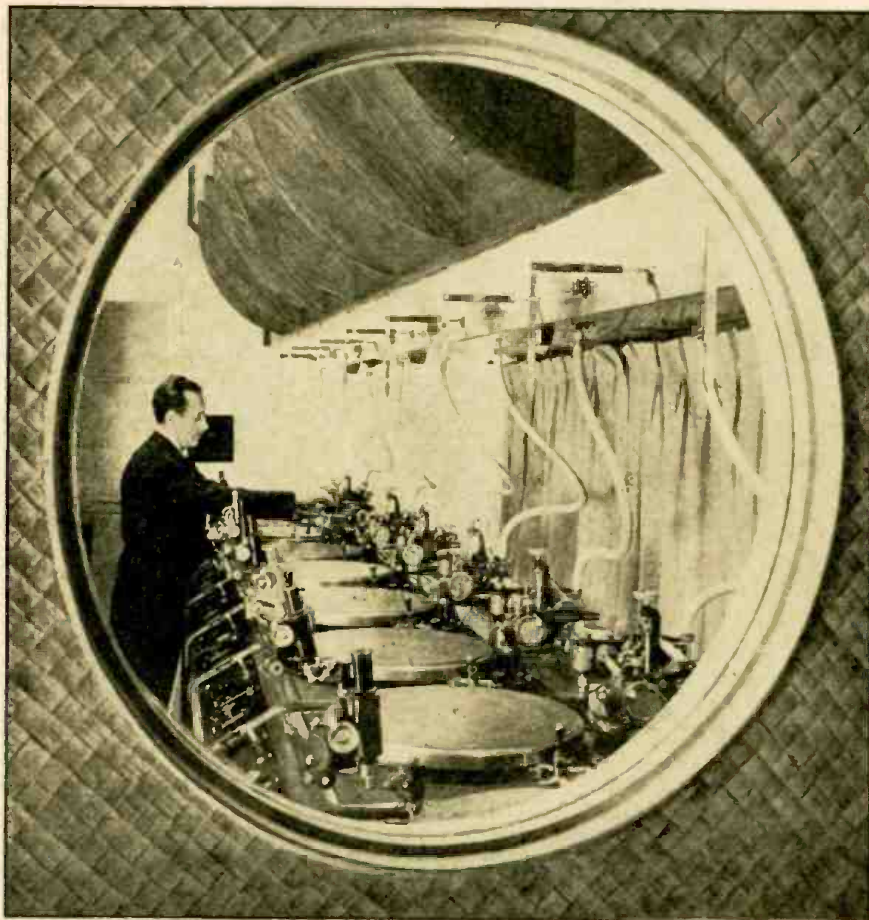

The battery of recording machines in the reference recording room of WOR's recording studios. Note the microscopes for examining the grooves, and the hoses of the exhaust system which takes away the minute chips and cuttings. Fourteen channels are available at all times, for "off-the-line" or "off-the-air" recording.

### NEW RECORDING STUDIOS

The new WOR recording studios, representing the last word in recording facilities, started operation last month.

Two new Scully recording lathes are used for cutting masters on lacquered glass discs. These recording machines represent the utmost in craftsmanship and precision, thereby enabling the production of the finest recordings obtainable.

Recordings can be taken "off the air" or "off the line," through some fourteen channels, with all channels interchangeable.

Special recordings can be prepared in the dubbing room; any desired combination of program or effects is possible.

### INSTRUCTOR POSITIONS OPEN

The Civil Service Commission announced last month that it is seeking Student and Junior Instructors for the Army Air Forces Technical Schools and the Navy Aviation Service Schools. Student Instructors receive \$1620 a year; Junior Instructors, \$2000 a year.

Student Instructors will be given training in radio operating, engineering, airplane mechanics, and shop work, for a three to six month period. Graduates of the course are promoted to Junior Instructor.

Student Instructors not subject to early draft, can qualify through completion of one

year's college study; through the possession of a Civil Aeronautics Administration ground instructor's certificate, airplane mechanic's certificate; or experience as a machinist, camera repairman, radio repairman; through completion of a six-month course in a radio school.

No written test is required. Applicant's qualifications will be judged from record of training and experience. Age limits are 20 years old and up.

Applications should be filed with the Secretary, Board of Civil Service Examiners, Chanute Field, Rantoul, Illinois.

There are also seven recording machines for reference recordings, which can be made at the same time as the master is cut.

The layout of the studios and control rooms is ideal. Both performers and engineers can see each other at all times and give cues on the split-second.

Since the rooms are all sound-proofed with respect to each other, the problem of ventilation was solved by using air-conditioning. Modern lighting also enhances the ease of workers and performers alike.

The studio itself is equipped with a folding wall so that proper acoustics "load" the mike to the best advantage.

### U. S. ARMY IN AFRICA BROADCASTS

When the American Army landed in Morocco November 8, they had with them a powerful long-wave transmitter.

Technical details of course are secret, but it may be stated that it was a powerful aid in the landing operations.

Operating on the same wavelength as the local station—Radio Morocco—it broadcast to the population President Roosevelt's message to the French people. Then Lieut. Gen. Dwight D. Eisenhower's orders to those of the French troops who were willing to act cooperatively with the U. S. landing forces, was broadcast, followed by General Henri Giraud's call to the French soldiers that the hour for them to restore themselves had come.

Radio Morocco (whose sponsorship and reliability has been questioned for some time) attempted to drown out the Army broadcasts by attempting "jamming" instead of broadcasting its usual material.

It tried to warn its listeners that a "clandestine" transmitter was operating on its wavelength, but to no avail. In the meantime the members of the German Armistice Commission were furious and fiercely demanded of the French authorities that they locate and smash the "clandestine" station.

But the Army station crashed through just the same and dramatically announced: "This is the transmitter of the American armed forces."

These soul-stirring broadcasts were heard even in London, and were rebroadcast by the British Broadcasting Corporation.

There is no doubt about the heartening effect such a broadcast by the Allied nations had upon the populace of the invaded country.

It certainly is to be expected that this will be one of the instruments of modern warfare, and one way in which the Allied nations can give mass intelligence to the citizenry of a country they are wresting from the Nazis.

### AMATEUR "WIRED" RADIO

Use by Prince George county (Md.) amateur radio operators of electric light and power lines instead of air waves may revise civilian defense communications nationally, it was learned last month.

Under the system, any house radio equipped with a simple special coil and tuned to the frequency used by the amateurs can receive civilian defense messages when plugged into a wall socket.

Thomas F. McNulty, chief of the War Emergency Radio Service of the Maryland Council of Defense, told of the system now being used by amateurs in the county, and said that the system, already viewed by Washington civilian defense officials, may revise communications systems nationally.

Two sending stations, one in Hyattsville, are in operation now, sending waves over ordinary electric light wires instead of through the air.

It was pointed out that enemy planes could not use the messages as a beam to locate objectives.

Seven transmitting stations are planned for the Prince George county network, and receiving sets will be placed in homes of all air raid wardens in the county.

McNulty said OCD officials in Washington were "very interested" in the system, (dubbed by the amateurs "wired wireless") and indicated it might be used for intercity communication in case of telephone breakdown.



## RADIO ON "HOME FRONT" IS WAR NECESSITY

The American Standards Association is starting "Victory" repair standardization at the request of OPA and the War Production Board. "The radio receiver in nearly every American home has become an indispensable part of the 'home front' in the maintenance of civilian morale and in the enlightenment of every American citizen on the conduct of the War, both at home and abroad," Dr. O. H. Caldwell, former Federal Radio Commissioner, said last month when he revealed that the American Standards Association has, at the request of the Office of Price Administration and the War Production Board, undertaken a program of standardization and simplification of radio replacement parts.

Dr. Caldwell is chairman of the War Committee on replacement parts for Civilian Radio. As soon as the committee which he heads, has completed its work of standardizing the myriads of parts used in home radio receivers, the WPB and OPA are expected to allot materials for manufacture of the standardized replacement parts and to issue limitation and price orders. The ASA standards will thus serve as a basis for assurance of continued operation of all modern home receivers for the duration of the war.

Considerable care is being exercised by the ASA committee to make sure that the quality of the standard repair parts chosen will be suitable from the set owners' standpoint. The "Victory" line of repair parts will be fully defined as to performance, dimensions and construction in the standards now in preparation. Sufficient parts of each type will be included in the standards to adequately service almost all of the modern home receivers in use today. Tubes are not included in the project.

In the design of these standard parts the ASA War Committee is making every effort to provide units that will be mechanically interchangeable with present parts with a minimum of difficulty. In addition, non-critical or less critical materials, and less of these materials, will be used wherever possible in these parts as compared with their peacetime proto-types.

Through simplification of the number of varied ranges now in use and the use of multi-purpose units when practicable, the actual number of parts will be held to an absolute minimum in the forthcoming standards. This will further serve to reduce the amount of strategic materials kept in inventory by minimizing the stock of parts held by jobbers and service men.

For example some 62 standard volume controls have been proposed to serve as replacements for the overwhelming majority of the thousands of different types used in home radio sets built during the past half dozen years, while 9 electrolytic, and 11 paper capacitors have been proposed to do a similar job in the capacitor field. Similar simplification and standardization in other radio parts such as transformers, chokes, coils, resistors, etc., is also included in the project now getting under way.

## S.W. STATIONS CLOSE

In the interests of national security and defense, and the successful conduct of the war, the Board of War Communications has ordered that the international radio broadcast stations WRUL, WRUS, and WRUW to cease operation.

In the meantime the Office of War Information will take over these stations and utilize the equipment for the best interests of the United States.

# NEW CIRCULAR FM ANTENNAS

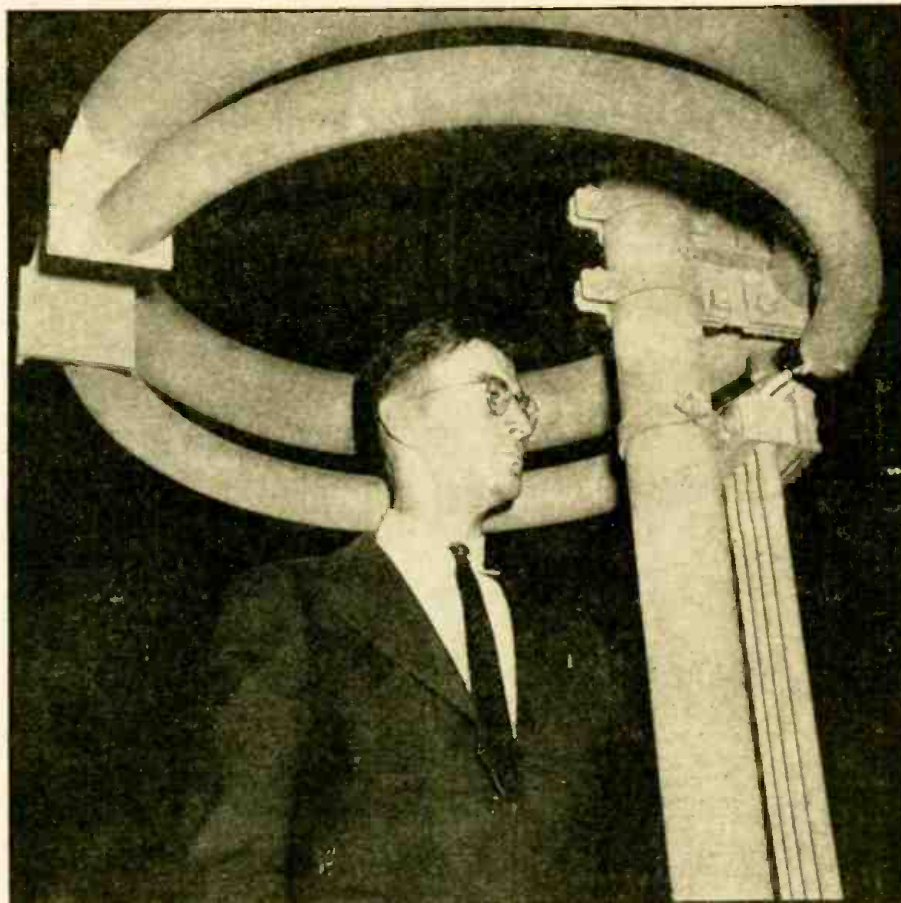

New circular type FM antenna developed by General Electric radio engineers and installed at W47NY. The outstanding feature of the antenna is its ability to radiate energy in all directions with uniformity, as contrasted to the costly structures previously used to secure a uniform radiation pattern.

Our front cover shows the new circular type FM antenna developed by General Electric Company radio engineers, and installed at W47NY.

The outstanding feature of the antenna is its ability to radiate energy in all directions uniformly, with a fairly simple physical structure. Heretofore a comparatively costly structure and complex phasing networks were required to obtain a uniform radiation pattern.

The antenna was designed primarily for FM, since its resonance characteristic is not broad enough for television transmission, and it can be adjusted after installation for best results.

Another feature is the fact that this antenna can be mounted on a metal pole without need for insulation in the supports. This feature of course makes the problem of lightning protection much easier.

The engineers arrived at this design through the normal evolution processes of development. They started off with a cubical construction such as was used in original television experiments. The cube consisted of two sets of four half-wave elements, with the two sets mounted horizontally, one above the other, thus giving a cube form.

Then experiments showed that effects similar to those obtained with the cube system, could be obtained by using a pair of half-wave elements in a V-shaped arrangement, with a 90-degree opening in the Vee.

The shape of the radiation pattern could be changed by varying the opening in the Vee, an angle less than 90 degrees usually yielding a better pattern.

The next thing tried out was an antenna consisting of two quarter-wave sections,

with each section bent into the form of a U-shape, with sides of equal length. The two sections were fitted together to make a square, with two of the sides overlapping.

This arrangement gave a circular radiation pattern, and physically was much smaller than the Vee-type or the cube arrangements.

Because the resistance to radiation of a circular type antenna is low, a second element was added to provide a step-up in impedance, by using the idea of the folded dipole.

This led to the final and present structure, which consists of circular elements spaced along the mast. The inside of the circle is at ground potential, therefore no insulation in the supports is necessary.

As now made the mast consists of a 4-inch diameter steel pipe, and the elements are made of steel pipe bent into circles having a diameter of 33 inches, to provide a center frequency in the 46 megacycle region. This is equivalent to a length of about 10 feet for a half-wave dipole of the same frequency.

Since this antenna is very much smaller than an ordinary dipole, some loss in signal strength is to be expected, but this loss amounts to only one decibel, and the antennas can be stacked to increase the field strength. The experiments have shown that optimum gain is achieved when the spacing between the units is about equal to a wavelength.

The gain in decibels (compared to the usual vertical half-wave antenna) varies with the number of antennas (or "bays") used. For example, if the number of elements be doubled a gain of 3 decibels should be expected.



# WHAT IS AHEAD IN ELECTRONICS?

By DR. LEE DE FOREST, Ph.D.; S. C. D.; D. Eng.

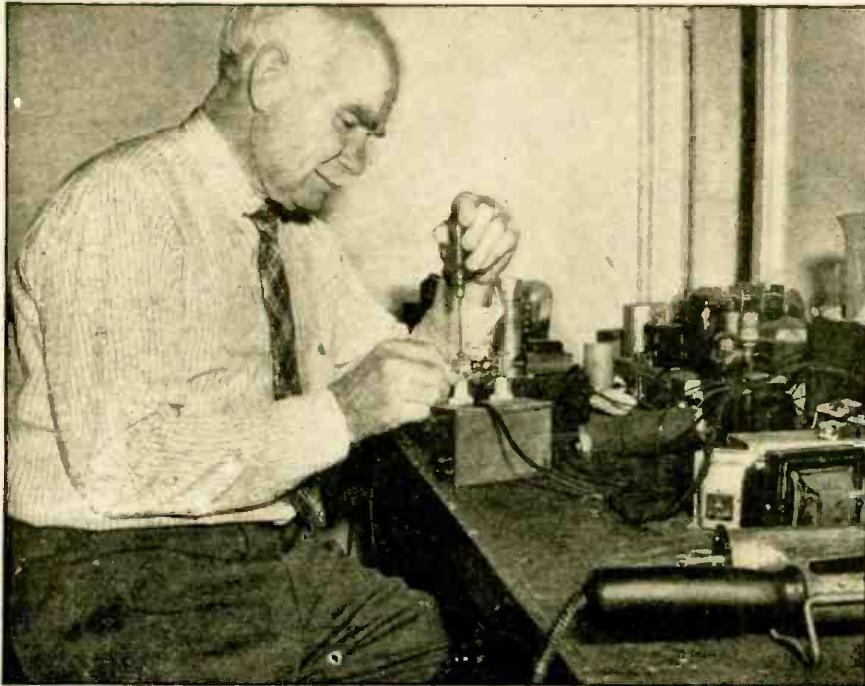

Dr. De Forest in his laboratory working on one of his latest devices.

It almost would be easier to answer the opposite of this question: "What is *not* ahead in Electronics?", so unlimited are the inviting vistas which now lie fallow before us as we examine the countless channels of development and application to man's uses of this tiniest element in the wide universe—the electron.

The growth of electronics is really vegetable in the rapidity with which this tiny seed, sown in the opening seasons of this century, has multiplied, furgated, branching out from a parent stem, until, like the tree in the old Bible parable, its branches literally fill the Heavens.

Even before this global war began, radio and telephone engineers were continually envisioning novel applications of the electronic grid tube and useful combinations of this with the photo-electric cell.

A recording spectrophotometer, utilizing photo-electric cells, provides the most reliable method of analyzing color ever devised, defining accurately some 2,000,000 different shades, working for textile, paper, chemical and paint industries. Electronic devices automatically square the lengthwise and crosswise threads in weaving. Electric eyes guard sheets of metal on a conveyor, discarding those with defects. Vacuum tubes turn on the lights as the sky darkens, turn them off when it is light.

Electronic devices, through carrier current, send messages and control distant apparatus linked only by power wires. Electronic rectifiers supply power to produce vital metals like aluminum. Electronic devices control the high-speed wrapping of packages, fill ginger-ale bottles to the prop-

er level, remove slate from coal at the mines, sort the pure crystals of rock salt, level elevators, open doors, control punch presses, detect smoke and fumes, measure vibration and thickness.

X-ray, priceless electronic tool of the doctor, now examines heavy steel castings for imperfections, detects porosities in welded seams, see hidden defects in automobile tires, searches candy bars for foreign materials, picks good oranges from bad, analyzes metals and alloys in terms of diffraction patterns.

And now the intensive development of Electronics, demanded by the necessities of modern warfare, has multiplied a hundred-fold the ingenious applications of the electron tube to uses and needs heretofore unpredictable. Foremost of these in the popular mind are the several applications in war work. These new principles, will, after the war, be equally useful applied to transport and private planes in the air, and at sea render collision in fog with ship or iceberg forever impossible.

Radio direction-finding devices, automatic homing systems, simplified blind landing beams, absolute altimeters, multifarious radio communication while in flight—all these advances have been greatly accelerated by war's demands. The future years of peace will immeasurably benefit by this enforced, often frenetic activity to make of modern aviation a science of safety. Modern aviation, as it is today, would be quite impossible without the generous aid of radio in its every department.

Frequency modulation has been taken from the commercial laboratories and been

redesigned for practical use in Signal Corps work, tank warfare and military uses. Thereby its later application to police requirements has been vastly improved—a field where its peculiar properties of static avoidance will be of far greater value than merely to transmit the ultra-sonics of broadcast music, unappreciated or unheard by the average human ear.

Television, laid away in mothballs for the duration, will most certainly burst into full bloom within a short time after peace has been declared, and the ban lifted. I predict that within 2 years thereafter, we will have safe, practical screen projection receivers for the home, giving us large size images which will be easy on the eyes, adequate in detail, and abundantly bright, and at prices within reach of the many, if not quite for the multitude.

A little later we are going to see 3-color television as optional with the black and white of today. The possibilities lying hidden in the crystalline materials of fluorescent surfaces are as yet but dimly appreciated. Therein lie fallow fields for research by the physical chemist. It is conceivable that surfaces may be discovered which, chameleon-like will change their vivid colors of fluorescence depending upon the degree, or wave length, of ultraviolet light flooding them, so that from the same screen may be obtained in proper sequence, the blue, the green, and the magenta to translate the electron stream into the true colors of the distant scene's reproduction.

Here again we will witness a sudden upsurge of television development and refinement, duplicating in form, if not quite in degree, the phenomenal rise and popular acceptance of the Radio Broadcast following the close of the last war.

For the intensive development of simplified, manufacturing processes and mass production methods which today's large radio manufacturers have been compelled to develop, will directly serve to equip these for economical quantity production of the new, improved television instruments and cathode beam tubes.

The genetic effect of electronic X-rays has already produced new kinds of flowers, many well improved strains of fruits, vegetables, and grains as seeds are bombarded with millions of volts. The electronic microscope has revealed to biologists the character of the tobacco mosaic virus, a deadly crop disease that has cost growers millions of dollars a year.

Radiography today discloses when broken bones are mending, when teeth are decaying, how to treat a sinus condition; it shows the presence of tuberculosis and silicosis. Then comes therapy, as X-rays treat skin disorders and infections and wage war against cancer, gangrene and gas bacilli. By inducethermy, another electronic application, heat is safely generated in living tissues. The electro-cardiograph amplifies the faint voltages of the heart muscle and records the action on photographic paper for the guidance of the physician.

Radio is no longer jazz, jive, "fit-music," or even music fit to hear, sandwiched be-





VARIOUS APPLICATIONS OF ELECTRONICS IN INDUSTRY

(1) Electronic tubes of various sizes and types as used in television and transmitting. (2) The most powerful X-ray machine in the world at the National Bureau of Standards, has 1.4 megavolt capacity. (3) Phototube system installed in cement kiln for temperature detection and control. (4) Water-cooled tube used in television transmitter. (5) Thyatron control panel controlling spot welder. (6) Herbert Duval, G. E. engineer, with model of new circular-type antenna for portable use. (7) Thyatron motor control alongside cable-stranding machine. These are only a few of the myriads of applications of electronic tubes and devices in modern industry. The art is growing by leaps and bounds and will open up unknown worlds for man's inventive genius.

—Photos courtesy of General Electric Company

tween commercial plugs. It is mobile police protection at all hours, weather observer, automatic pilot, instant communication for fireboat and fire truck, operator of remote power stations, fire fighter, cradle watcher. It has been made to serve as well as to amuse and educate. After peace reigns again, radio, made visible by television, will transport us to Washington, the ball game, aboard a racing sloop, or to a lecture room. Electronics has in store for millions of homes performances that as yet have never been imagined.

Air transport pilots will have constantly before them, on the screen of a cathode-ray tube, clear warning of any obstacles ahead, so that mountains will lose their terror in darkness, and thick weather, and blind landings will be facilitated. At sea the ship's pilot will detect nearby shipping or icebergs through fog and darkness as plainly as in clear weather by day.

Today, with that magical Aladdin's lamp, the electron tube, the engineer can command electrons so that they will do his bidding. For the first time he has hold of electricity

itself—not just its manifestations. All that has gone before is only a preparation for a new and greater adventure in living.

In the early days of the electrical application, the Morse Telegraph monopolized, almost alone, the stage of commercial development. Then came Edison, Tesla, Elihu Thomson, and Sprague, to lead this communication agent out into the streets, the factory, the far-reaching trolley lines. Thus modern industry blossomed gigantically through the stimulus of electric power. And  
(Continued on page 252)



Many of our readers are interested in electronic applications of radio circuits, etc., and this article should be of interest to them, as it discusses light and lenses, the theory of which is so important to phototube applications.

# OPTICS AND ELECTRONICS

By JOHN R. KEARNEY

THOSE interested in electronics find it essential to have a good understanding of the basic principles of physics which apply in this field. Ordinary light, as an example, is familiar to all of us and we take it for granted. Yet, if you go into the subject, you will find more than enough to occupy your attention for hours on end. But we are interested chiefly in its practical aspects.

Let's examine some of the properties of ordinary light. We may define light as the agent which produces vision. In a dark room we cannot see, but where there is light we do see, and the degree of vision depends on how much light is present.

**LIGHT**

Light must be present upon the *object* which is to be seen. If we have a light in our eyes produced by the glare of a lamp in a street car and look out into the dark street, we cannot see objects in the street because the light on them is not sufficient. Light must be present on the object to be seen. The light must pass from the object

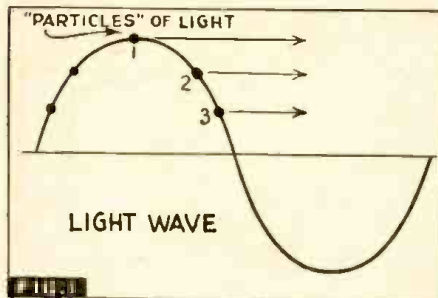

to the eye, and in some cases light can be seen at the edges of an object behind which a light is shining. Under such conditions, *diffraction* may occur, this being the deviation of the light rays from a straight course when partially cut off by an obstacle.

When passing through an opening or near an opening, light rays may be diffracted and will be accompanied by *prismatic* colors due to interference of the light waves. The word *prismatic*, in case you had forgotten, means refracted or formed by a prism, or exhibiting rainbow tints as the result of prismatic action.

The word *refracted* meant that the light ray is bent or turned aside, deflected from its straight course, as the result of the sections of the light *wave-front* having different velocities in a non-homogeneous medium. That is, in Fig. 1, the velocity of

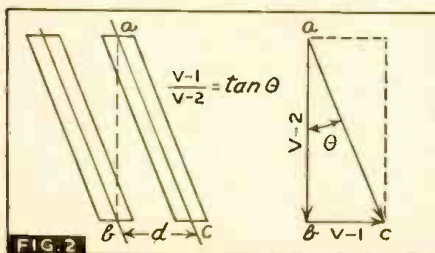

particle number one might be different from that of particle number two, and as a result the wave shape would be bent by the action of the medium.

Ordinarily, all parts of the wave would travel at the same velocity. However, in oblique passage of the wave from one medium to another, or in a medium whose density is not uniform, refraction occurs. As an example, an electron moving in a non-uniform electrostatic or electromagnetic

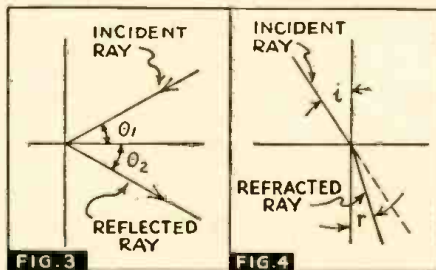

field may be bent or refracted, as in a television tube.

The word "homogeneous" means of the same composition or structure throughout. Substances such as paper or muddy water may transmit light, without allowing objects to be seen clearly, and are termed *translucent*. They are not homogeneous bodies, but light in passing through them is scattered in all directions at the surfaces of the innumerable little particles throughout the mass. Even transparent bodies, such as glass or water, reflect at the surface, a part of the light that falls upon them. Bodies may be transparent for some kinds of light and opaque to others, which is caused by the body colors. Electronic apparatus may use light filters on lenses to exclude various kinds of light and to permit entrance of infra-red or some other special kind of light, giving the system a selectivity character.

**INTENSITY OF LIGHT**

An important principle is that *light travels in straight lines* in a medium of uniform character. Like radio waves and other forms of radiated energy, light energy varies inversely as the square of the distance from the source. If the light on an object is 2 foot-candles at a distance of 4 feet, the light intensity at 8 feet will be:

$$I-2 = \frac{(1-1) (d-1)^2}{(d-2)^2} = \frac{(2) (4) (4)}{(8) (8)} = \frac{1}{2} \text{ foot-candle}$$

The foot-candle is the standard measure of light. An idea of values of light intensity in foot-candles can be gained by consideration of the following arbitrary ratings:

Good illumination for reading—4 foot-candles; poor illumination for reading 1 to 2 foot-candles; full moonlight 0.02 foot-candles.

**VELOCITY OF LIGHT**

The velocity of light is practically instantaneous, being about 186,000 miles per second. This is roughly equivalent to a billion

feet per second. Or, in one billionth-of-a-second light travels 1 foot of distance, approximately.

Aberration is the displacement from the mean position, as the result of velocity of the object or of the source. As an example, consult Fig. 2. The telescope is pointed at a star, but the earth is moving in its orbit with a velocity of 18.51 miles/sec., so the eyepiece moves a distance "d" between "a" and "b" at a velocity V-1. The tangent of the angle is:

$$\frac{V-1}{V-2} = \tan \theta$$

where V-2 is the velocity of light. Recent aberration observations give the constant of aberration as 20.492" and the velocity of light then, is:

$$V-2 = \frac{18.51}{20.492} = 186,000 \text{ miles per second}$$

An ultra-high-frequency radio wave may have a length of 1 meter, (equivalent to

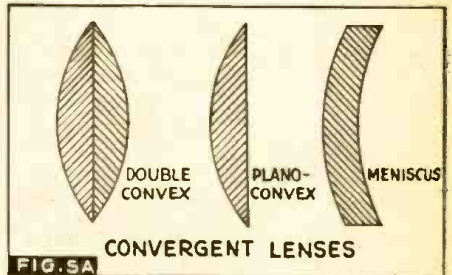

3.28 ft.), while a light wave has a length of one billionth of a foot, roughly.

**REFLECTION OF LIGHT**

Like radio waves or heat waves, if the light waves strike a good reflector they will be turned back at the same angle and with little loss of energy. The requirements of the light reflector differ in many respects from those of radio wave or heat wave reflectors, but in general the light reflector should be smooth, highly polished and clean. An accumulation of dust, grime and dirt cuts down the efficiency of a reflector or of a lens in an electronic device. In the same way, fog or snow will cut down such signals. An idea that does not seem to have been exploited is to use super-sonic frequencies or ultra-sonic waves for electronic alarm systems, such waves having short lengths which are less affected than light waves by changes in the air mass. If sound

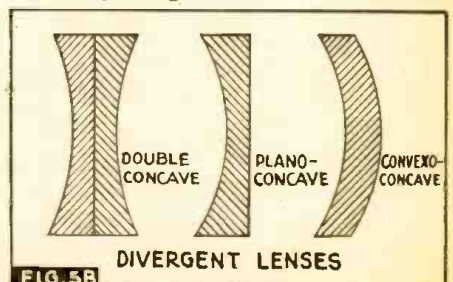



is assumed to have a frequency of 1100 ft./sec., the wavelength at 30,000 cycles would be 0.036 meter, equivalent to about twelve hundredths of a foot.

**REFRACTION OF LIGHT**

When light strikes a perfect reflector, the angle of incidence is equal to the angle of reflection. In Fig. 3, the angle  $\theta-1$  would be the same as  $\theta-2$  under such conditions. The

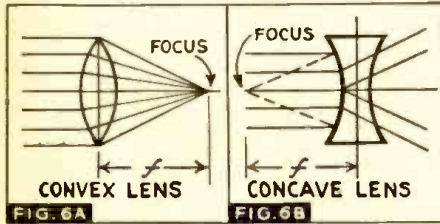

action is different when the light wave passes through a medium having a different density or structure than the original medium. As shown in Fig. 4, if light strikes the surface in the horizontal plane at an angle  $i$ , with the vertical it will not continue

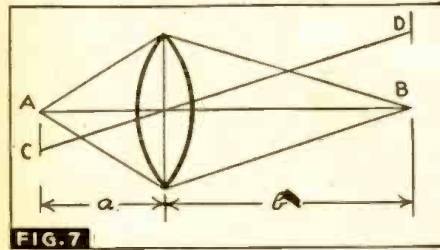

in the original direction but will follow a new path. This route will have an angle "r," with the vertical and Snell's law states:

$$\frac{\sin i}{\sin r} = \mu$$

where  $\mu$  is the index of refraction. The ratio of velocity of light in vacuum to that in the substance is called the "index of refraction" of the substance. Some indices for sodium light are:

Very dense flint glass	1.71
Light crown glass	1.51
Diamond	2.47
Water	1.33
Air	1.000292

**LENSES**

Lenses are pieces of glass or other transparent substance usually bounded by spherical surfaces, and are used in forming optical images. The line which passes through the center and which joins the spherical surfaces is called the "principal axis."

In Figs. 5A and 5B, a number of lenses are shown. In the convergent lenses, light rays focus at point F, or "converge at F." In the divergent lenses, plane waves advancing along the axis are more retarded at the edges than at the center and emerge from the lens as spherical waves expanding from a center F. The difference in these two actions is shown in Fig. 6.

In Fig. 7, the conjugate foci are points "A" and "B," and the focal length of the lens is "f." For convergent lenses, f is positive, and for divergent lenses, f is a negative value. When light from any point A passes through a lens, upon emerging from the lens it is either directed toward or away from some other point B, these points being the conjugate foci. If the lens is thin, the line joining the points will pass through the center of the lens, but when the lens does not coincide with the principal axis of the lens, the line between C and D is called the secondary axis.

Where transmission of light over a long route is necessary, a lens system permits more efficient operation than can be obtained without some form of focusing of the light rays. In Fig. 8, a light bulb sends out a beam which is picked up by a photoelectric cell. The filament of the lamp bulb has a height  $d-1$  and the height of the object, or its diameter, is  $d-2$ . The relationship may then be expressed,

$$\frac{A}{B} = \frac{d-1}{d-2}$$

$$\frac{1}{A} + \frac{1}{B} = \frac{1}{f}$$

In a practical problem, it might be known that distance B is to be a certain value and the proper value of focal distance "f" and of distance between lens and bulb is to be determined. The diameter of the object and lamp filament height would be known factors. Then,

$$B = \frac{(A)(d-2)}{(d-1)}$$

$$\text{and } f = \frac{1}{\frac{1}{A} + \frac{1}{B}}$$

All dimensions, it should be observed, must be in the same units; inches or feet, not both. For that matter, the metric units can be used.

**REFLECTORS**

The amount of light reflected depends not only on the material of which the reflector is made, but upon the color and wavelength of the light. The wavelengths are given in microns. A micron is a

millionth of a meter. A table showing these wavelengths and the per cent reflection for various mirror or reflector surfaces is given below:

Percent Efficiencies of Reflection

Color	Wave-length	Silver	Monel	Stellite	Zinc
Deep Red	0.45	94.1	63.7	71.8	61.0
Light Red	0.65	93.5	61.8	71.0	60.0
Deep Blue	0.45	88.0	56.5	63.5	54.0

Various forms of reflectors have been used. As the result of experience in the practical work of building headlamps, motorists were given efficient lamps employing a double convex lens and an elliptical mir-

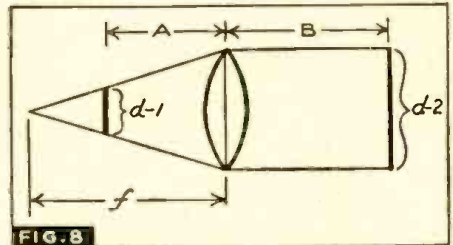

ror reflector, the bullet shaped type often seen. This development of the automotive engineers could be applied equally well in electronics to secure a strong beam for long distance transmission within line of sight.

**PRACTICAL APPLICATION OF ELECTRONIC CONTROL**

For any specific application, it is well to consult the companies specializing in this field. Names and addresses may be obtained from any trade directory. In this field no bungling or half-done jobs are tolerated. In many cases electronic control is not (Continued on page 218)

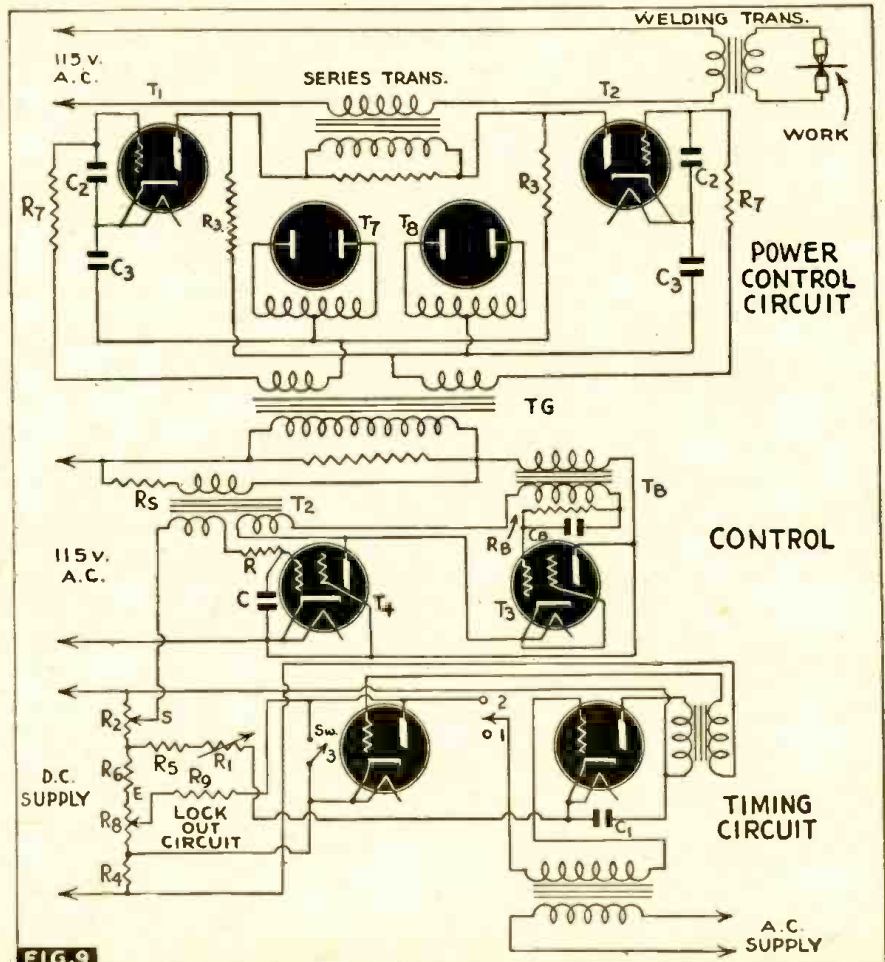



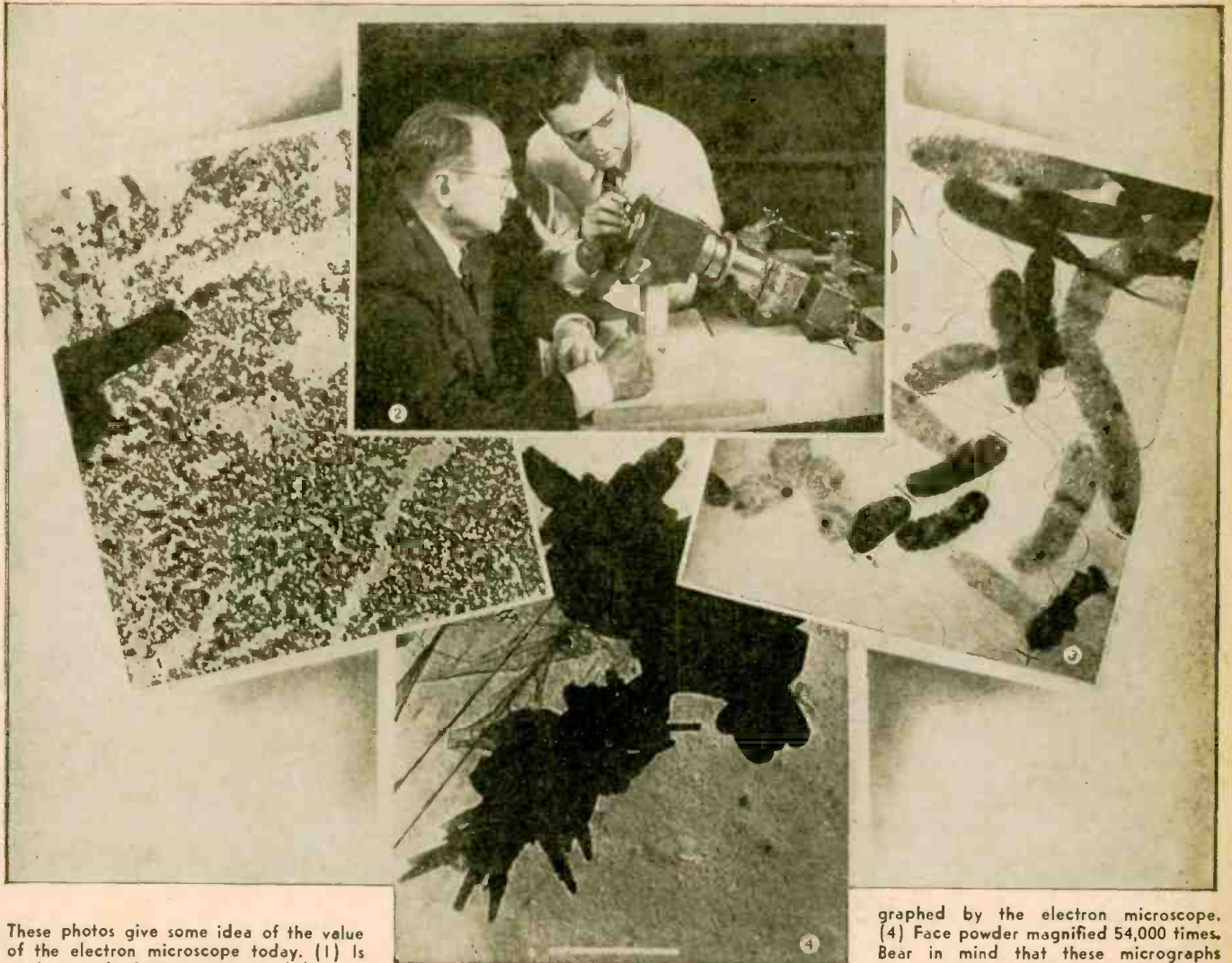

These photos give some idea of the value of the electron microscope today. (1) Is a micrograph of mercurochrome. (2) Shows Dr. V. K. Zworykin, Associate Director of RCA Laboratories, and Dr. James Hillier, inspecting the new mobile electron micro-

scope which they developed, which can magnify up to 100,000 times. (3) Bacterium vibrio schuylkilliense (commonly found in streams), as micro-

graphed by the electron microscope. (4) Face powder magnified 54,000 times. Bear in mind that these micrographs show "depth", owing to the three-dimensional photographing ability incorporated in the electron microscope; a valuable aid in research.

# NEW ELECTRON MICROSCOPE

**A** NEW electron microscope, small enough and inexpensive enough to be available to industrial, medical and research organizations, has been developed by RCA Laboratories, it was announced last month, by Dr. V. K. Zworykin, Associate Director, at the Chemical Conference in Chicago.

Only 16 inches long and light enough to be carried, the new model can magnify up to 100,000 times, virtually the equal of the standard instrument, which was introduced two years ago.

Also exhibited for the first time was the standard machine, and a gallery of photomicrographs.

Scientists of the RCA Laboratories in reporting on the performance of the microscope to date, list the following outstanding discoveries and accomplishments:

1. Photographing of the influenza virus.
2. Secret work on the development of polymers as applied to plastic and artificial rubber.

3. Studies of textile fibres which may lead to better tires; longer-wearing clothes.

4. Study of bacteriophage virus and its effect on bacteria.

5. Examination of crystal growths.

6. Study of surface structure of metals by the replica method, resolving detail unexplored by the light microscope.

7. Stereoscopic micrographs, producing images with third dimension.

8. Through the high resolving power and large depth of focus of the instrument, accurate calibration of magnification is possible and particle size and distribution determined.

9. Photographing of tobacco mosaic virus, and the study of anti-serum in the control of plant viruses.

10. Discovery of the fact that virus particles have internal structures, as found in the vaccinia virus.

11. Recording the action of germicidal agents on individual bacteria.

12. Adaptation of the electron microscope to production control of paints and inks.

13. Investigation of smokes and dusts, both beneficial and harmful types.

14. Studies in ceramics and related fields.

Magnifications up to 100,000 diameters are obtainable which are 50 to 100 times more powerful than the strongest optical microscope.

For instance, a blood corpuscle is magnified to a diameter of a 2-foot sofa pillow. A dime thus magnified would appear more than a mile in diameter; or a human hair would appear as large as a giant redwood tree.

To accomplish such magnifications the electron microscope uses electrons—infinite bits of electricity—instead of light rays; and magnetic or electrostatic fields instead of glass lenses.



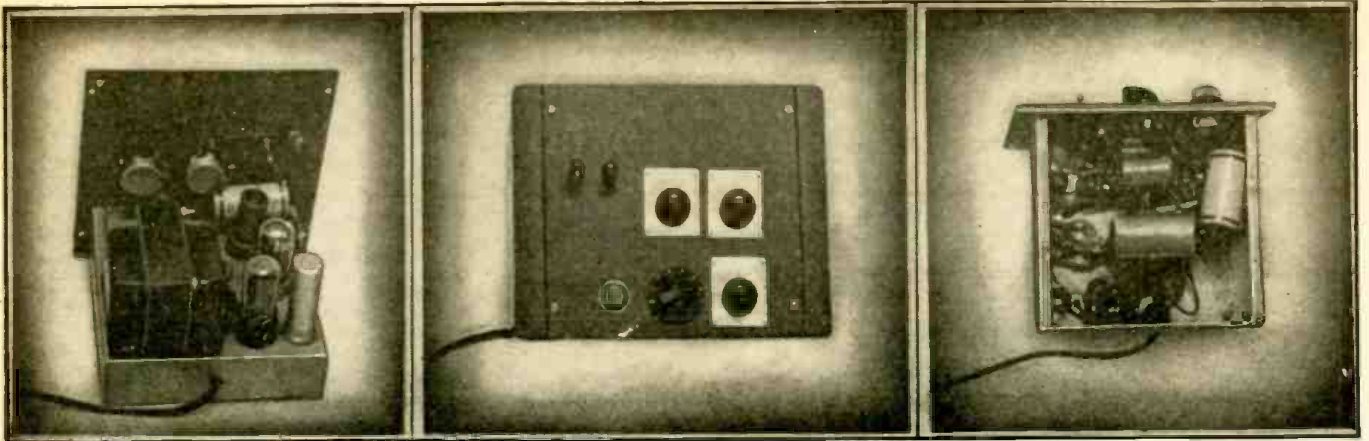

The photos show the square-wave and pulse generator as constructed by the author. The picture on the left is top view of chassis; in the center is shown the front panel appearance; and at the right is shown the under view of chassis. Neat, compact and thoroughly shielded.

# A VERSATILE SQUARE WAVE AND PULSE GENERATOR

## PART I

By WARREN MILLER.

**T**HE instrument which will be described is easily constructed and in its application is one of the most useful instruments for the experimenter, technician and engineer.

When the instrument is operated as a square-wave generator it can be used for complete audio measurements such as transmission line measurements, audio-frequency amplifier checks, filter checks, pad or network checks, and a number of other uses where a quick observation of the frequency response characteristic of a particular system is required.

### NATURE OF MEASUREMENTS

Due to the nature of square waves (exact details are omitted since they are highly technical), that is, as they are generated, the transmission of same through any form of apparatus, will show the defect or the perfection of said apparatus, because perfect reproduction requires perfect response over a wide band. For it must be remembered, a square wave has, besides its fundamental frequency harmonics of the fundamental wave in its character, and the number of harmonics present usually run up to the tenth harmonic of the fundamental.

For example, if we have an amplifier whose frequency response is to be observed, the following setup is required, (see Fig. 1).

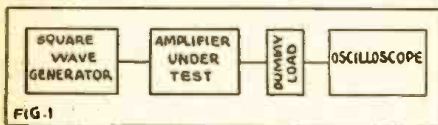

Block diagram of set-up.

A dummy load, pure resistive, equal to the load the amplifier normally works into, is connected across the output terminals. The vertical deflecting circuit of an oscilloscope is connected across a dummy load. The output of the square wave generator is fed into the input of the amplifier. After turning all the necessary power switches on, a 60 cycle square wave is used for the first check. Now, referring to the previous mentioned fact of multiple harmonics, besides the 60 cycle wave also the second, third, fourth, up to the tenth harmonics,

or a 600 cycle wave is passed through the amplifier. If the frequency response is good the observed wave will be the same as the input wave form except amplified. Figure 2 shows input 60 cycle wave and output 60 cycle wave.

Suppose, now, that the output looks like Fig. 3a, Fig. 3b or Fig. 3c. We see immediately that the amplifier is not operating correctly, but is causing distortion. The distortion present may be due to several reasons, for example, in Figure 3a, lack of high-frequency response; Figure 3b, ex-

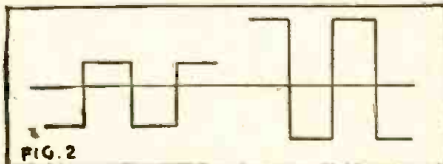

Square wave forms.

cessive high frequency-response; Figure 3c, improper grid bias in one of the audio stages, third low-frequency errors, etc.

### VALUE OF MEASUREMENTS

So we can readily see how quick and easy we can check the frequency response of almost any audio device. If we would go up higher in frequency, say up to 1000 cycles, assuming that the low frequency response was good, the amplifier to be perfect would have to extend up to 20 kilocycles for reproduction of a perfect square wave, for the same patterns observed for the low frequencies, hold good for the higher frequencies.

The form of the patterns, with few variations holds fairly true for all measurements. If one were to make the same test with a sine-wave oscillator, the task would be far greater and much more difficult. Thus the time used for making an accurate and true measurement with a square wave generator, is very small, compared to a sine-wave measurement and also is far more accurate. **SPEED AND ACCURACY ARE THE BYWORDS OF THE SQUARE WAVE GENERATOR IN**

### THE RESPONSE MEASUREMENTS OF AUDIO DEVICES.

Although the generator, whose description follows, is not an absolute laboratory standard, its performance for average use is excellent, the writer using the same instrument for frequency measurements of wide-band amplifiers. A more elaborate instrument with high accuracy will be described at some future date.

### CIRCUIT DETAILS

As can be seen, only three tubes, oscillator, squarer, and a cathode follower are used besides the rectifier. The fact that only three tubes are used shows the efficiency of the circuit. The average laboratory instrument uses up to six tubes with slightly better performance.

For the experimenter's purposes this three-tube unit will be an excellent boon.

A short description of individual functions of the various tubes will now be given. A 6SC7 twin triode (any other twin high-mu triode will do also), (low-mu triodes are not recommended because they require a small feedback condenser from second output plate to No. 1 input grid), is used in a multivibrator circuit.

Feedback so as to cause oscillation is

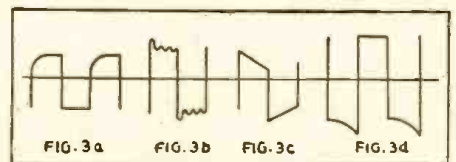

Various output waveforms.

readily available without resorting to any additional capacities. The high mu of the tube, plus distributed capacity of the circuit, will cause sufficient oscillation. SW-4 is the rough frequency-control selector, and R3 is the fine frequency-control selector. The condenser values as given will give good overlap at all frequencies.

The full range covered is from about 40 cycles to 60 kilocycles, with a little distortion at 40-80 cycles, and from 40 kilocycles (Continued on page 249)



# RADIO FREQUENCIES SPEED TIN PLATING

WESTINGHOUSE engineers announced last month a process which does a better job, faster, with great saving of time and material, in the electroplating of steel.

This is accomplished by using a high-frequency oscillator and having the tin strip pass through the oscillator coil.

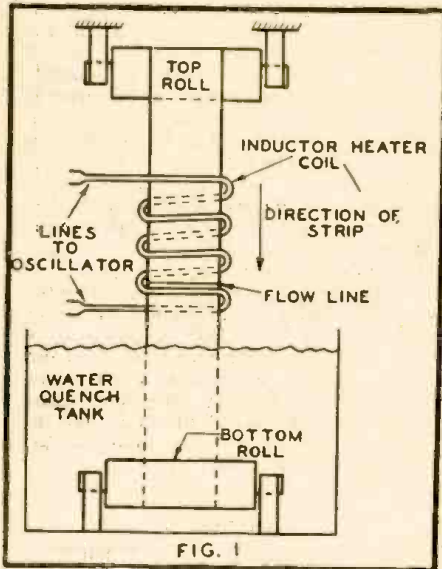

Granular tin deposit reflowed at 452 deg. Fahr. The electrolytically plated strip, dried by hot air, enters the inductor heater coil at 130 deg. Fahr. Here it is heated by high frequency current to the melting point of tin, 450 deg. Fahr., after traversing about 90% of the coil length. At this temperature the rough tin deposit flows into a smooth surface. The strip then runs through the water quenching bath where the tin is hardened and the temperature reduced to about 100 deg. Fahr.

quency oscillator and having the tin strip pass through the oscillator coil.

The coil induces eddy currents in the strip, and due to skin-effect, concentrates the heat in the tin layer where the metal fuses, and smooths out to a glossy desirable finish.

Then the strip is submerged in water to cool and end the fusing process.

The advantage of this process lies in the fact that whether the plating is done in

molten bath or by electroplating, the smooth finish can be obtained at low cost and with high efficiency.

The radio oscillator used delivers 200,000 cycles per second. Alternating current is converted to direct current by means of a high voltage transformer and electronic rectifier.

The D.C. power applied to the plates of a bank of 3600-K.W. vacuum tube oscillators, similar to those used in a broadcast transmitter, is converted into high-frequency power. The resonant frequency of this power is determined by the tuned circuit consisting of the oscillator tank coil and the tank condenser.

Water-cooled copper tubes conduct this high-frequency energy to the inductor heater coil which surrounds the tin-coated steel strip.

By means of electromagnetic induction, energy flowing in the electric circuit is transferred to the rapidly moving strip where it is converted into heat. The strip acts as a 1-turn closed circuit.

This process is another step in the application of modern physics to industrial process; an inkling of what will be more widespread after the war.

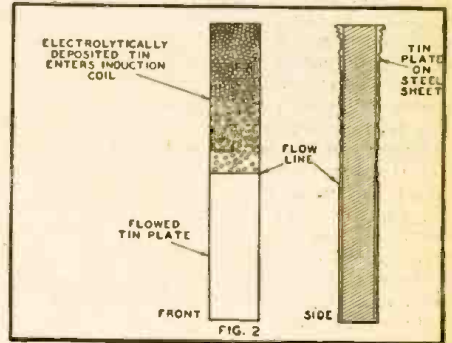

Peaks Fill the Valleys. When the heat, caused by the eddy currents, raises the temperature of the tin to the fusion tin, the granular deposit on the steel sheet flows out into a smooth shiny surface.

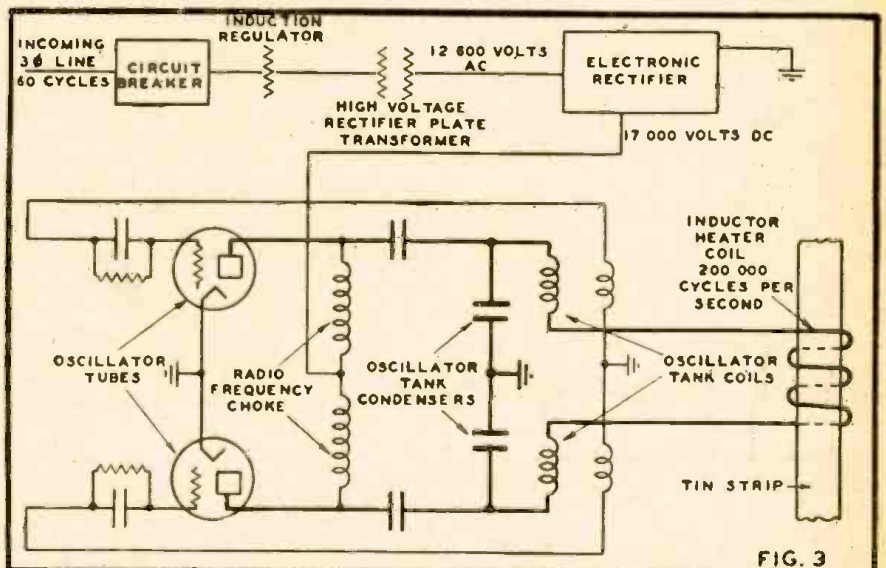

Circuit of the high power oscillator and inductor heater coil as used in the new Westinghouse process for obtaining smooth high-polish tin plate. Note the simplicity of the arrangement.

## THE ELECTRONIC COP

If you're driving over the speed limit, at night, a flashing sign will tell you so.

This is the recent application of the photo-electric cell and its associated circuits, as developed by the General Electric

Company. A community can do itself and the motorist a service, and at the same time collect some kind of revenue, indirectly by way of taxes, on illuminated signs bearing advertising, as shown in illustrations.

Of course you are not supposed to be going over 35 miles an hour these days, but the idea is presented at this time because it was developed during the past year, and will probably find widespread application after the war.

Here is how it works. A section preceding the sign is marked off by two light beams. Suppose only one car enters the section. It breaks the first beam and the timer is started and the circuit "sealed-in."

As the timer operates, it closes successive circuits, depending on the time it takes the car to pass through the section.

When the car breaks the second beam, the timer is stopped, and the circuit to the sign is closed (through the contact which was in position when the timer stopped) and the sign flashes the warning if the speed through the section exceeded the limit.

The sign remains lighted for a definite time, independent of the first timer, and then

(Continued on page 254)





# A NEW FREQUENCY DIVIDER FOR OBTAINING REFERENCE FREQUENCIES

By F. R. STANSEL

ONE of the common characteristics of all non-linear devices, such as vacuum tubes, is the generation of harmonic frequencies. With a pure sine-wave input, the output will contain a series of multiples of the input frequency. For many purposes, of course, this harmonic generation is disadvantageous, but for others, it is very helpful. In our work, for example, reference frequencies of 1, 10, and 100 kc were obtained for many years from a 100-cycle tuning fork by harmonic generation.

For more than a decade, however, piezoelectric oscillators have been used as sources of reference frequencies because of their high stability. Since it is desirable to operate these oscillators at a frequency higher than those of the standards—usually at 100 kc—a sub-multiple generator, or frequency divider, is required to secure the desired lower frequencies.

Frequency dividing circuits are not so well known as frequency multipliers. The earliest one, dating back to about the time of the First World War, is the multivibrator. This device, as shown in Figure 1, consists essentially of a two-stage, resistance-coupled amplifier with its output fed back to its input.

When this circuit is oscillating, the plate current of tube No. 2 is of saw-tooth shape as shown below the schematic. Although in-

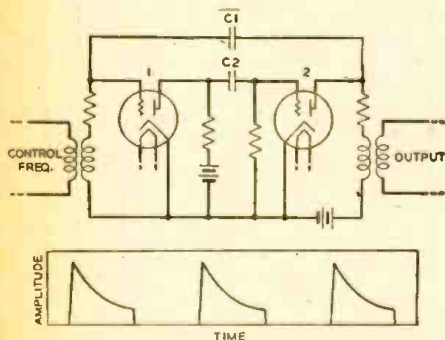

Fig. 1—Simplified schematic of a multivibrator, and outline of waveform of its output.

fluenced by the natural frequency of the system, the output frequency of a multivibrator is unstable when no control frequency is applied.

By introducing a small amount of control current, however, either by the method indicated in Figure 1 or in any one of a number of other possible ways, the saw-tooth oscillations may be locked in step with the control frequency, which may either be the natural frequency of the system or some multiple of it.

With a 1,000-cycle multivibrator, for example, and a 5,000-cycle control frequency, the multivibrator will lock-in on every fifth cycle, and the fundamental output frequency will thus be one-fifth of the control frequency.

## MULTIVIBRATOR CIRCUIT

Multivibrator circuits have been widely used for frequency division but they have a number of disadvantages. Inherently the multivibrator is a self-oscillating circuit whose only merit lies in the ease with which

its frequency can be controlled. Once this control is lost the device becomes worse than useless since an output is obtained

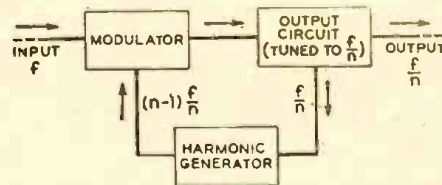

Fig. 2—Block schematic of basic circuit of a regenerative frequency divider.

which is entirely unrelated to the original controlling frequency.

Because of this there is always the possibility of a reference frequency generated by a multivibrator being "off frequency." The danger of "off frequency" operation is further enhanced in some cases by an occasional annoying tendency of the multivibrator to jump from one submultiple to another.

Although the stability may be improved by modifications of the circuit of Figure 1, and by careful design, this likelihood is a fundamental defect which can never be entirely eliminated.

This defect applies also to the multivibrator's first cousin, the controlled oscillator, another device which has been used at various times for frequency division.

Another disadvantage of the multivibrator is its wave shape. For some types of work its saw-tooth wave shape with high harmonic content is a definite advantage, but for most uses in laboratories, particularly for frequency standardization by means of Lissajous figures, a much purer wave shape is required. Because of this, when the predecessor of the present reference frequency equipment was installed in 1931, a series of special output filters was required to clean up the output of the various multivibrators.

## FREQUENCY DIVIDING CIRCUITS

In recent years several new types of frequency dividing circuits have been developed. Of these probably the most successful is the regenerative frequency divider, which has today entirely replaced the multivibrator in the reference frequency system at our laboratories.

The basic form is shown in Figure 2. It consists essentially of three elements: a modulator, an output circuit tuned to the sub-multiple frequency to be produced, and a harmonic generator.

Once this circuit is in operation, its action is easy to understand. Assume, for example, that the input frequency is 100 kc, and that the output is 20 kc. Part of the output is fed back to the harmonic generator, where its fourth harmonic, 80 kc, will be selected by a tuned circuit.

This 80 kc current and the 100 kc input will result in a difference of the modulator, and in a number of other frequencies as well. The 20 kc frequency, however, which is the output frequency desired, is selected by the tuned circuit.

To start the oscillators, there must be some 20 kc component present in the cir-

cuit. In some regenerative frequency dividers this is supplied by a pulse applied from a starting circuit, but in more recent circuits it has been found possible to omit the starting circuit, and to depend on the transient voltages normally present in the circuit for this starting pulse.

In general, when the "nth" submultiple frequency is desired, the harmonic generator is tuned to the (n-1)th harmonic. An interesting case arises when the output frequency is to be half the input frequency. Under these conditions (n-1) is equal to 1, and no harmonic generator is required. Part of the output is fed back directly to the modulator.

Unlike the multivibrator, the regenerative frequency generator cannot operate without an input frequency. Should the input frequency fail, the output drops to zero, and thus off-frequency operation does not occur. In addition, the output current of the generator is a relatively pure sine wave, and additional "clean up" filters are not required as they are with the multivibrator when a sine wave is desired.

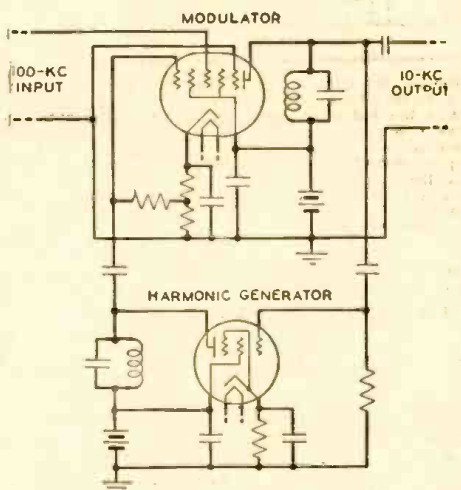

Fig. 3—Frequency divider circuit as used in special standard frequency equipment, recently developed, and now used by Western Electric.

These and other advantages led to the adoption of a circuit of this type for the reference frequency equipment recently provided for the Western Electric Company. A schematic of the circuit is shown in Figure 3.

A pentagrid-mixer tube is used for the modulator and a pentode for the harmonic generator. With a modulator tube having two shielded input grids, it is possible to eliminate the balanced modulators and transformers required for the earlier regenerative frequency dividers; and with the increased modulator gain obtained, not only is it possible to eliminate the starting circuit, but frequency division as great as 10 to 1 is obtainable in one stage.

Heretofore, two dividers in tandem would have been required for a 10 to 1 division, one giving a 5 to 1 reduction and, followed by a two to one reduction stage.

—Bell Laboratories Record



# A SIMPLIFIED ELECTRONIC VOLTMETER

By HAROLD DAVIS

## PART I

**W**HILE the uses of an electronic (VTVM) volt-meter are many and varied, the instrument is known best for its ability to check A.V.C. and grid bias circuits. For this purpose, the conventional one mil, 1000 ohms per volt meter is useless because of the comparatively low resistance = 5000 ohms on the 5-volt scale.

Even the 20,000 ohm-per-volt jobs have too low a resistance to shunt a high resistance A.V.C. and diode load. These circuits often exceed a megohm and nothing under several megohms can be shunted across them without seriously affecting the A.V.C. voltage.

Few servicemen know as much about A.V.C. circuits as they would like to. This is due to the fact that without some form of electronic meter, they have had nothing with which to measure and trace A.V.C. and accordingly get a first hand idea of what it was all about.

### GOOD A.V.C. CIRCUITS

There is nothing complicated about A.V.C. circuits. They are simple rectifier circuits and perform exactly the same function as the power rectifier in the set. The diode or second detector tube rectifies the R.F. carrier which is filtered and fed back to the converter and I.F. tubes as a bias voltage, which accordingly rises and falls in direct proportion to the radio signal being received on the antenna.

The difference between the A.V.C. circuits and the power rectifier is in the size of the components. Due to the difference in frequency, 0.0001 and 0.00025 condensers will filter the R.F. voltages, as well as the 8-mfd. will filter 60 cycle current.

The exact size of the components are not critical. The resistors are governed by the diode load requirements; most manufacturers recommending not less than 100,000 and not more than 1/2 meg. The condensers must be so chosen that they will by-pass R.F. and will block audio signals. This value is usually about 0.00025 mfd.

A typical A.V.C. circuit is shown in Fig. 1. Here the diode load consists of R1, R2, and R3. R1 is a 50,000-ohm resistor that feeds the audio load. This resistor decreases the audio load, which in turn enables a higher audio load resistor to be used. And, due to the fact that the other resistors are so high compared to R1, the audio drop across it is not appreciable. R2 is 200,000

ohms, which serves as a filter, and R3 is 250,000, completing the load.

This particular circuit is used only in the better class receivers where the signal that reaches the diode is large due to the R-F amplification ahead of it.

The by-pass condensers pass the R-F component but are not large enough to affect the audio signals. However, C3 is large enough to pass all signals, R2 serving as an isolating resistor between it and the audio circuit.

R4 is one megohm and has a value of 2 megs or more in some circuits. It prevents any reactance between circuits. Besides this main isolating resistor, each grid circuit is further isolated from the other by another resistor, usually 100,000 ohms.

To check this circuit it is necessary only to follow the A.V.C. voltage along the network, to the grid of the tubes controlled by the A.V.C. voltages. Practically the only things that can happen is a resistor might open or a condenser might short. But a leak in the 1 megohm resistor will seriously affect the voltage.

Should the by-pass condensers open, it will permit R.F. to be fed back to the tube grids, causing distortion.

### A.V.C. IN CHEAPER SETS

In the cheaper sets, the circuit in Fig. 2 is often used. The diode is connected through a 50,000 ohm-resistor directly to the volume control, which becomes a part of the diode load. The grid of the first audio is fed through a coupling condenser and is automatically biased by a 10 to 15 megohm resistor to ground.

In this particular circuit this coupling condenser must be kept comparatively small, 0.005 being a good value, or over-loading will occur on high volume. The insulation must also be good or it will furnish a path for the A.V.C. voltage to reach the audio grid.

### DELAYED A.V.C.

Sets using Delayed A.V.C., while becoming increasingly fewer, might require special mention. Delayed A.V.C. does not mean that the A.V.C. waits until the signal gets through the tubes before it grabs it, but does mean that it waits until the signal reaches a certain level before it becomes effective.

The purpose of delayed A.V.C. is to permit greater sensitivity on weak signals. If A.V.C. begins to function as soon as a signal hits the diode, regardless how small the signal is, it will still reduce the sensitivity of the set accordingly. If, however, the A.V.C. action is delayed until the signal reaches a given proportion, the set will respond much more readily to weak signals.

Delayed action is often accomplished by biasing the diode that furnishes the A.V.C. voltage, the amount of bias being 1.5 to 3 volts. This can be done easily when a tube such as the 6H6 is used, by simply using a resistor in the cathode of the proper size. The diode coupled to the audio load cannot be biased, naturally.

### BIASING A.V.C.

Other methods of biasing the A.V.C. diode are accomplished by returning the diode to a negative spot on the voltage divider, or by utilizing the drop across resistors in the plate and cathode circuits.

### A.V.C. VOLTAGE

The amount of A.V.C. voltage to be expected varies with the particular set, but it is usually 5 to 10 volts on local stations. On large sets it will reach 15 volts on strong signals, and is often only a volt or two on cheap midgets.

Measurements are made from the electrical ground of the set to the diode, or anywhere along the A.V.C. network, even at the grids of the controlled tubes. The idea is not to find out, "how much" voltage is present, but rather if it is being distributed evenly. However, weak A.V.C. could mean a weak detector tube, as the A.V.C. voltage is a pretty good indication of detector action.

### OSCILLATOR ACTION

The electronic volt-meter can be used to check oscillator action of a superhet. When a tube oscillates, grid current flows. This amounts to 0.25 to 0.4 milliamperes in the case of the 6A8. A grid leak resistor of approximately 50,000 ohms usually is used. If 0.4 mils flows through 50,000 ohms, 20 volts will be developed.

This voltage can be measured across the gridleak with the electronic meter. Actually, this voltage is less than 20 volts, due to reduced plate voltage and smaller grid leaks. However, it is always present when the set is oscillating and reads negative from ground.

When the tube is not oscillating, the voltage will be positive or zero. The grid-leak voltage will vary slightly with frequency.

### AUDIO MEASUREMENTS

The electronic meter reads audio voltages without rectification. Audio signals are not A.C., but instead pulsating D.C. The one-megohm coupling resistor serves as a filter. A blocking condenser should be used in series with the probe resistor if the points to be contacted contain any D.C. voltage.

As an audio indicator, the meter may be used as an output meter by contacting any point in the audio system. To prevent fussing around finding a contact point and mak-

(Continued on page 243)

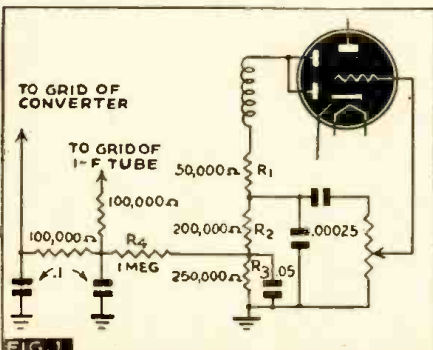

FIG. 1

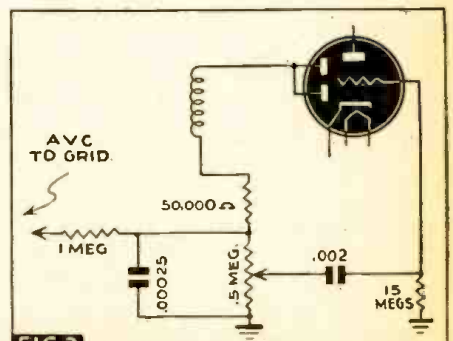

FIG. 2



Tear down and reassemble in 100 minutes. That's the goal the students set for themselves in handling engine generator sets. This kind of work appeals strongly to the mechanically minded.



How to solder efficiently is one of the important details of instruction.



Modern testing equipment is used to check assemblies, circuits, alignments, output and waveform, so essential in high quality transmission and reception. The skill developed in this kind of work is used later to great advantage.



# NEW YORK STATE SIGNAL CORPS SCHOOL

**H**UNDREDS of young men, without previous knowledge or experience in radio are learning the fundamentals of electrical theory, radio design, repair and maintenance, in the space of a few months. That is the record of the civilian training unit at 63 Park Row, New York City.

Shattering the traditions of the past, and all the pet theories of the pedagogues, an intensive course is given which enables an expert radioman to be produced in about one eighth the time that it took in pre-war days.

Young men, and even oldtimers, learn how to design filters (high, low, bandpass, 120 cycle, etc.). They know how to calculate voltage, current, impedance and power induced and transferred, in R.F. and I.F. coils, output transformers, etc.

They tear down old radios and equipment of 1930-to-1940 vintage, and re-assemble the material into units of 1-tube stages, or remount on suitable chassis.

They can take apart then build up and operate a gasoline-engine-driven generator set in 100 minutes.

When the school had trouble finding new equipment, it bought up all the derelict radios and equipment it could find in the New York Cortlandt Street second-hand marts, tore them down completely (giving the heavy metal chassis to the salvage campaign) and used the components to make breadboard layouts.

The student thus builds up a 1-tube unit to a superhet; or a 1-stage amplifier to a full power amplifier with power-pack.

Nothing is left to guesswork. Each man is enthusiastic and eager to learn and does his utmost to grasp every detail of practical work and theoretical explanation.

Servicing with the oscilloscope is another valuable experience. Alignment, examination of output for distortion, measuring modulation percentage—all these become second-nature to the student.

All students are well-grounded in mathematics including algebra, trigonometry, and the use of the slide rule. Math is not so hard when you have a definite use for it, and the boys take this in their stride.

With a course like this, these men are thoroughly prepared for immediate accept-

ance into the Signal Corps as maintenance and repair men for field, tank, and aircraft radio.

Those who excel will be considered for candidacy in more advanced schools, or in transmitter construction, repair and maintenance.

Those who cannot complete the stiff theoretical part of the work, concentrate on developing skill in repairing radio equipment.

## SCOPE OF COURSE

The course consists of two sections, of three months each. During the first section, the student (who is a mechanic learner) receives \$1020 per year. (All students must enter on this basis.)

Successful completion of this section automatically leads to the position of Junior Radio Repairman, at \$1440 per year.

The use and care of essential tools, basic shop practices, study of basic mathematics and electrical fundamentals, and the reading of electrical circuit diagram is included in the first section of the course.

The second section takes up advanced work in the field of radio. Upon completion of the course the trainees are well equipped to handle, maintain and repair almost all types of Signal Corps radio equipment.

## QUALIFICATIONS FOR ADMISSION

All applicants must be men 18-44, in good physical and mental health, certified by the Civil Service Commission to the Signal Corps representative. The applicant must pass a mechanical aptitude test as given by the Civil Service Commission.

If successfully interviewed, the applicant must then enlist in the Enlisted Reserve Corps of the Signal Corps. By so doing the applicant is completely released by his selective service board, and is permitted to attend school for his pre-service training.

During this period, the reservist maintains his civilian status. Upon completion of the course, the reservist is called into active service as a private. However, with the training that a man receives in the school, he should advance in grade much faster than a man who has not had this training.

Furthermore, if a man shows possibilities

as officer material he may have the opportunity to apply for Officers Candidate School after completion of his basic training. Upon his graduation from O. C. S. he will be commissioned a Second Lieutenant in the Signal Corps of the Army.

## HOW TO APPLY FOR ADMISSION

Obtain Form No. 4000-ABC from nearest 1st or 2nd class post office; the Civil Service Commission at 641 Washington Street, New York, or from the Secretary, Civil Service Commission, 63 Park Row, New York, N. Y.

Under the heading of the application which reads: "Exact title of the examination for which you are applying," the applicant should fill-in the following words: "Mechanic Learner (Radio)".

When the form has been filled-out, those applicants who wish to take the examination in New York City will mail the application to the Secretary, Civil Service Commission, 63 Park Row, New York, N. Y.

All other applicants must mail their applications to the Civil Service Commission, 641 Washington Street, New York City.

Thereafter the applicant will be notified as to where and when he should report for examination.

## RADIO CODE OPERATORS SCHOOL

A shorter, twelve-week course, is also being given by the Civilian Training Section, to men who are interested in learning the International Morse Code and radio code procedure as used in the Army Signal Corps.

At the present time this course is given only in New York City, and the qualifications for admission are the same as for the Radio Mechanic Course.

If an applicant is interested in this course, he must apply for the training exactly the same as for the Mechanic Course, except that under the heading of the application where it asks for "Exact title of examination for which you are applying," he should fill-in the words: "Mechanic Learner (Code)".

So you young men who want to do your bit and at the same time learn a skill which can always be used, get busy and sign up. It is never too late.





Westinghouse Table Model—WR-290

**PUSH BUTTON ADJUSTMENT**

The push buttons connect to separate magnetite-core oscillator coils and separate antenna trimmers which must be adjusted for the desired stations. Use an insulated screwdriver or alignment tool. Allow at least five minutes warm-up period before making adjustments.

In the event that the receiver is to be used with an external antenna use one or two feet of wire (as an antenna) to ensure sharp peaking during the final adjustment procedure. For loop operation, the link should be strapped across "A" and "G" terminals on back of set. In either case the procedure is as follows:

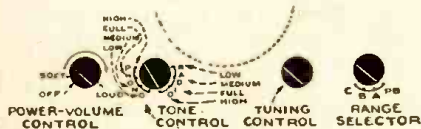

**Location of Controls.**

1. Make a list of the desired station, arranged in order from low to high frequencies.
2. Turn the range selector to "A" band, and manually tune in the first station on the list.
3. Turn Range Control knob to "PB" and Press push button No. 1 and adjust No. 1 oscillator core to receive this station. Screw the core all the way in, to lowest frequency, and then unscrew slowly until station is received.
4. Adjust No. 1 antenna trimmer for maximum output on this station.

Owing to the relatively high R-F gain, it may be found that there are several settings of each push-button magnetite core that will bring in any particular station. In such cases it is advisable to unscrew the push button antenna trimmers to minimum capacity before adjusting the oscillator cores.

Clockwise adjustment of cores and trimmers tunes the circuits to lower frequencies.

5. Adjust for each of the remaining stations in the same manner.
6. After all stations are tuned-in on the buttons, make a final careful adjustment of all core rods until best reception is obtained for each. Outdoor antenna should not be reconnected if used.

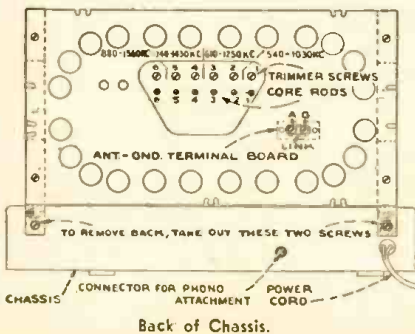

Back of Chassis.

**WESTINGHOUSE RADIO  
MODEL WR-290**

**Eight-Tube, Three-Band, AC, Superheterodyne  
Receiver with Built-in Loop Antenna**

**Frequency Ranges**

Broadcast	540-1,600 kc
Medium Wave	1.56-4.0 mc
Short Wave	5.8-18.0 mc
Intermediate Frequency	455 kc

**Tube Complement**

- (1) RCA-6SK7 R-F Amplifier
- (2) RCA-6SA7 1st Detector-Oscillator
- (3) RCA-6SK7 I-F Amplifier
- (4) RCA-6SQ7 2nd Detector, A.V.C., and A-F Amplifier
- (5) RCA-6SF5 Phase Inverter
- (6) RCA-6K6GT Power Output
- (7) RCA-6K6GT Power Output
- (8) RCA-5Y3-G Rectifier

**Power Supply Ratings**

105-125 volts, 50-60 cycles, 90 watts

**SPECIFICATIONS**

105-125 volts, 25-60 cycles, 90 watts

**Push-Button Ranges**

- One station between approximately, 540-1,030 kc
- Two stations between approximately, 610-1,250 kc
- Two stations between approximately, 740-1,430 kc
- One station between approximately, 880-1,560 kc

**Power Output Rating**

- Undistorted 5.0 watts
- Maximum 5.5 watts

**Loudspeaker (RL-79-A5)**

- Type 6-inch Electrodynamic
- V.C. Impedance 3.4 ohms at 400 cycles

**ALIGNMENT PROCEDURE**

**Cathode-Ray Alignment** is the preferable method. Connections for the oscillograph are shown in the chassis drawing.

**Output Meter Alignment.**—If this method is used, connect the meter across the voice coil, and turn the receiver volume control to maximum.

**Test-Oscillator.**—For all alignment operations, connect the low side of the test-oscillator to the receiver chassis, and keep the output as low as possible to avoid a-v-c action.

**Calibration for Alignment.**—The proper dial calibration for alignment purposes can be set up in two ways:

1. The dial may be removed from the cabinet by sliding out the two spring pieces which clamp it in its mounting position. The condenser plates should then be turned into full mesh, the pointer adjusted to the scratch at the left end of the dial backing plate, and the dial slipped under the pointer so that its extreme left calibration mark coincides with the pointer. The dial may be held in place with scotch tape. In this manner the actual receiver dial is used for alignment. When alignment is finished, the scale should be replaced including the fibre light shields which are folded under the ends of the glass scale.
2. A calibration scale is attached to the tuning drum. The correct setting of the gang, in degrees, for each alignment frequency is given in the alignment table. Check the position of the drum, making sure that the 0 degree scale mark is horizontal with the gang in full mesh.

**Pointer for Calibration Scale.**—If method (2) is used, improvise a pointer for the calibration scale by fastening a piece of wire to the chassis, and bend the wire so that it points to the 0 degree mark on the calibration scale when the plates are fully meshed.

**Details of Alignment Procedure**

**Step No. 1**—Connect the high side of test oscillator to 6SK7 I.F. grid in series with 0.01 mfd. Tune test oscillator to 455 kc. Turn radio dial to "A" band to a quiet point between 550 and 750 kc. Adjust L-21 and L-22 (2nd I.F. Transformer) for maximum peak output.

**Step No. 2**—Connect the high side of test oscillator to 6SA7 grid in series with 0.01 mfd. Tune test oscillator to 455 kc. Turn dial to "A" band to a quiet point between 550 and 750 kc. Adjust L-19 and L-20 (1st I.F. transformer) for maximum peak output.

**Step No. 3**—Connect the high side of test oscillator to the antenna terminal in series with 300 ohms ("A" antenna trimmer C-11 should be 1/4-turn out). Tune test oscillator to 15.2 mc. Turn radio dial to 15.2 mc. (149°) on the "C" band. Adjust C-24 (Osc.), C-15 (Det.), Rock gang, C-1 (R.F.), and rock gang for maximum peak output.

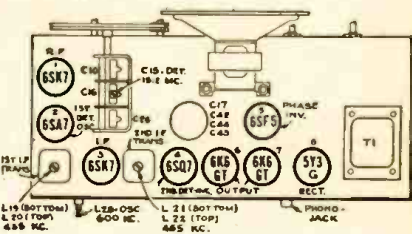

Tube and Trimmer Location.

**Step No. 4**—Connect the high side of the test oscillator to the antenna terminal in series with 200 mmf. Tune the test oscillator to 2.44 mc. Turn the radio dial to 2.44 mc. (91.5°) "B" band. Adjust C-27 (Osc.) and C-19 (Det.) for maximum peak output.

**Step No. 5**—Connect the high side of the test oscillator to the antenna terminal in series with 200 mmf. (Preset "A" osc. trimmer C-28 1/4 turn out.) Turn test oscillator to 600 kc. Turn radio dial to 600 kc. (30.5°) "A" band. Adjust L-28 Rock gang for maximum peak output.

**Step No. 6**—Connect the high side of the test oscillator to antenna terminal in series with 200 mmf. Tune test oscillator to 1.500 kc. Turn the radio dial to 1.500 kc. (160°) "A" band. Adjust C-28 (Osc.), C-20 (Det.), and C-11 (R.F.) for maximum peak output.

**Step No. 7**—Repeat step 5, then 6.

**Step No. 8**—Connect the high side of the test oscillator to antenna terminal in series with 300 ohms. Tune test oscillator to 15.2 mc. Turn radio dial to 15.2 mc. (149°) "C" band. Adjust C-1 (R.F.) and rock gang for maximum peak output.

\*Use minimum capacity peak if two can be obtained. Check to determine that C-24 has been adjusted to correct peak by tuning receiver to approximately 14.29 mc. where a weaker signal should be received. Note.—Oscillator tracks above signal on all bands.

To reduce sensitivity during R.F. Alignment connect a 15,000 ohm, 1/4 watt resistor across secondary of first I.F. transformer.

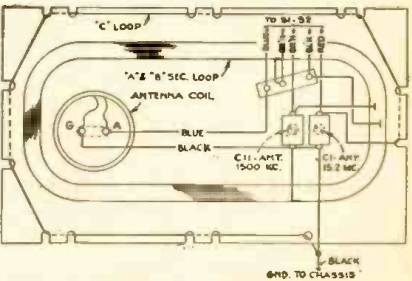

Loop Connections and Trimmers.



# Radio Service Data Sheet

329

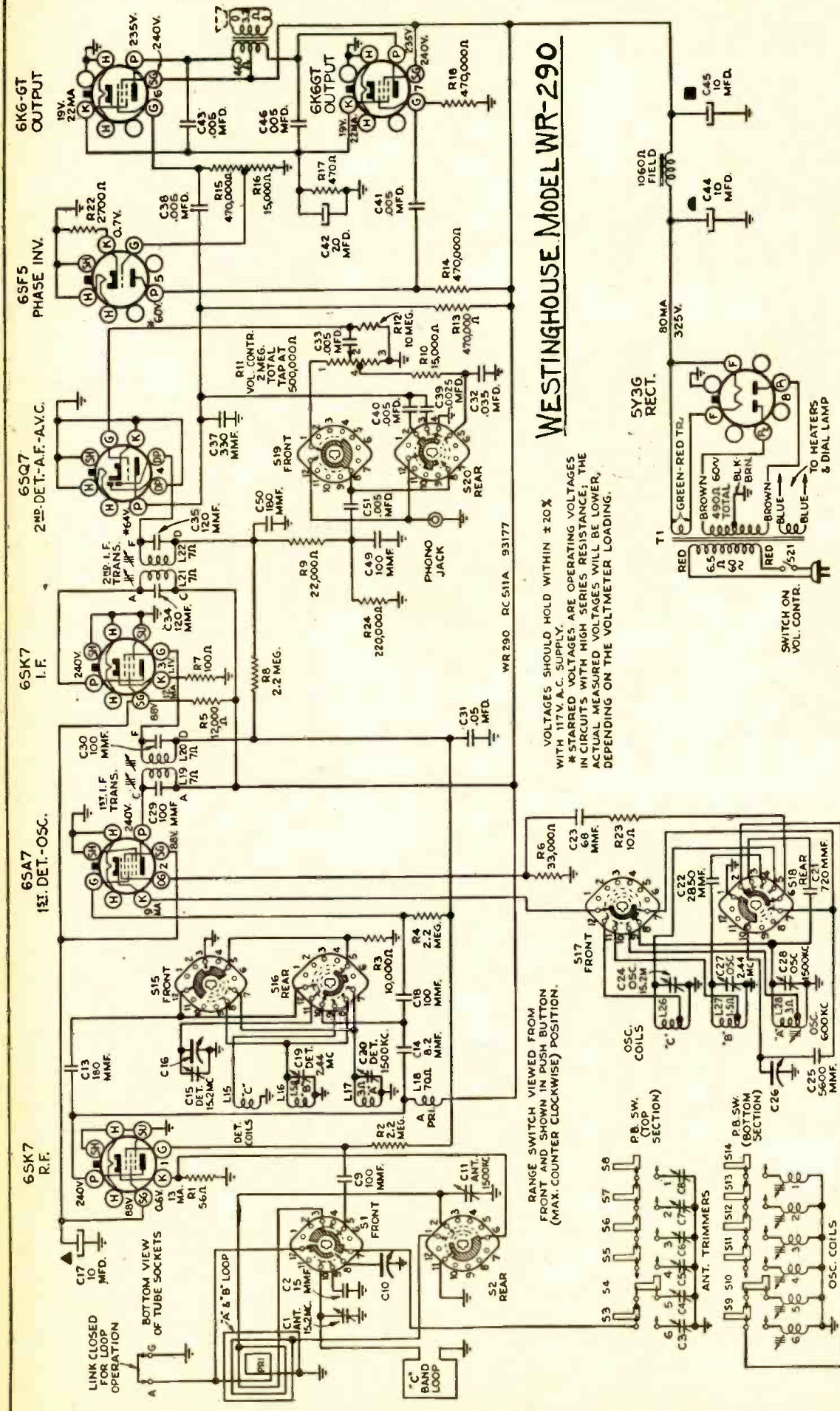

## WESTINGHOUSE MODEL WR-290

VOLTAGES SHOULD HOLD WITHIN  $\pm 20\%$  WITH 117V. A.C. SUPPLY.  
 \* STARRED VOLTAGES ARE OPERATING VOLTAGES IN CIRCUITS WITH HIGH SERIES RESISTANCE; THE ACTUAL MEASURED VOLTAGES WILL BE LOWER, DEPENDING ON THE VOLT-METER LOADING.

### PARTS LIST

- Capacitor—180 mmfd., moulded mica
- Capacitor—330 mmfd., moulded mica
- Capacitor—2,580 mmfd., silvered mica
- Capacitor—2,580 mmfd., silvered mica
- Capacitor—5,600 mmfd., tubular
- Capacitor—0.025 mfd., 1,200 volts
- Capacitor—0.05 mfd., 400 volts
- Capacitor—Electrolytic—comprising 3 sections of 10 mfd. 450 volts, and 1 section of 20 mfd. 25 volts
- RESISTORS
- Resistor—100 ohms, 2 watts
- Resistor—2,700 ohms, 1/2 watt
- Resistor—10,000 ohms, 1/2 watt
- Resistor—12,000 ohms, 3 watts
- Capacitor—15,000 ohms, 1/4 watt
- Resistor—22,000 ohms, 1/4 watt
- Resistor—250,000 ohms, 1/4 watt
- Resistor—470,000 ohms, 1/4 watt
- Resistor—2.2 meg., 1/4 watt
- Resistor—10 meg., 1/4 watt
- Resistor—58 ohms, 1/4 watt
- Resistor—100 ohms, 1/4 watt
- RESISTOR NETWORKS
- Coil—P.B. oscillator coil—low frequency (1)
- Coil—Push button oscillator coil (2, 3, 4, 5, 6)
- Coil—Oscillator coil (L26, L27, L28)
- Indicator—Station selector indicator
- Loop—Antenna loop winding
- Loop—Antenna—Ground, board
- Shaft—Tuning shaft and pulley
- Socket—Dial lamp socket
- Socket—Phonograph input socket
- Coil—Det. coil (L15, L16, L17)
- Condenser—Variable tuning condenser
- Control—Volume control (2 meg.) and power switch
- Core—Drive core
- Core—Core and stud for oscillator coil
- Dial—Calibrator dial
- Drum—Tuning condenser drive drum—less calibrator



# HOW TO HOOK UP RADIO RECORD PLAYERS

By JOSEPH A. INNESS

**P**ERHAPS one of the most neglected forms of radio servicing a man can render his customers, is the proper connections of record players to radios. And yet if properly done, can mean cash returns for himself, instead of headaches.

Today there are in use thousands of these record players equipped with high impedance crystal pickups. Just what percentage of these record players are properly connected to their respective radios is in doubt. It is the writer's opinion that a great number of these record players have never been properly attached since through his own experience he has found many players in use where the connections to the radio were in some cases nothing short of depressing. (This does not necessarily imply that the "depressing" connections were made by servicemen.) Conditions were found such as the following:

One lead from the record player was connected to the grid cap of the 1st audio tube, the other to chassis, with such connections not very solid at that.

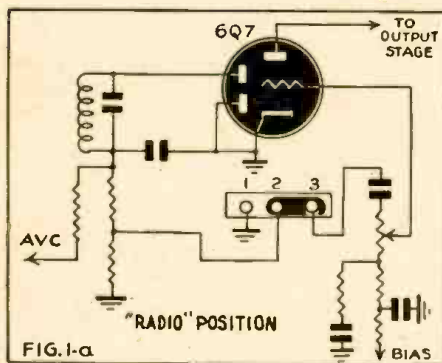

Connections to a midget receiver.

Another instance was where the record player leads were fastened to the 3-contact terminal strip provided on the back of the chassis of some sets with the shorting bar left in the dangling position, which meant that if the set was tuned to a strong station radio reception would get through the audio system as well as the desired recorded music or speech. If the set was not tuned to a station any noise which was amplified in the RF-IF section would likewise reach the speaker.

To correct such conditions it would be necessary to arrange the shorting bar in such a way as to short it to the ground contact to eliminate radio reception.

## ANALYSIS OF RECEIVER TYPES

Set owners who have the above conditions are not very well satisfied and are willing to pay for having their record players attached in such a way as to obtain record reception without objectionable hum and without interfering radio stations or noise. On the other hand they do not want their record players to hamper their radio reception. In addition some means must be provided for quick change-over from radio to records or vice versa, whereby it isn't necessary to connect or disconnect wires, etc.

With the above ideas in mind it will be seen that for proper connections and for top

*This article discusses the proper connections to be made to the more common types of radio circuits when hooking up record-players. While many servicemen know all the tricks, there are probably some who are not so familiar with the methods used. It is for this latter group that the author outlines suggestions and recommendations based on his experience.*

performance of radio and record player alike some thoughtful analysis of the situation is necessary. First let's classify the different types of radios in regard to record players.

1. The later model sets which either have a radio-record switch built into the back of the chassis, or have the record player switch at the front of the cabinet, either pushbutton controlled or knob controlled and usually found as one position of the band switch.

2. Sets which are provided with a terminal strip on the back of the chassis to accommodate record players.

3. Sets which have no accommodation whatsoever for record players.

Of the first group we are not especially interested, inasmuch as the set manufacturer (with some exceptions) has done a perfect job of making the proper provisions for phonograph. It is group 2 and 3 which requires our attention. Let's consider the second classification.

## TERMINAL STRIPS

Look at Fig. 1a. Here we have the terminal strip scheme shown in the "radio" position. In Fig. 1b the "proper" connections for record playing is illustrated. Evidently some set manufacturers never intended the shorting bar to be placed across contacts 1 and 2 but want it to be left dangling; which is obvious in cases where considerable manipulation is necessary to get the shorting bar across terminal 1 and 2. It will be readily observed that to go back to "radio" from the position shown in Fig. 1b (or from the "dangling" position), requires a change of connections, meaning that the shorting bar has to be placed as in Fig. 1a. Such inconveniences as this will not meet with the approval of the set owner who doesn't want to bother changing connections. So another scheme will have to be devised.

Suppose then that we install a single-pole-double-throw switch as in Fig. 1c. Here we have a convenient means of changing quickly from radio to records. It would seem that this system should be satisfactory. It would be in the "radio" position, but not so in the "records" position, for along with the recorded selections there will be interfering radio reception by a tuned-in station, or noise in one form or another.

Looking at the switch again it will be noted that when the switch is in "records" position the audio channel from the diode detector is open and there is no physical connection between "Rad." and "Rec." or between points 2 and 3. However, there is a capacity between these contacts, which, even though very small, in view of the high-grain audio systems of most sets with diode detection, will permit the signal from

the diode detector to hop across the terminals and be amplified to a considerable magnitude. Our aim then is to find a solution that will eliminate radio reception when playing records.

Let's take a double-pole-double-throw switch of the non-shorting variety, such as Mallory 3222J, and really do this job well. Instead of fooling around the terminal strip with the switch outside the chassis, mounted on the cabinet or left hanging, we shall find a place at the back of the chassis large enough to accommodate the rotary switch which has a 1/4 inch shaft and a 3/8 inch bushing, which means that we shall drill a hole in the chassis 3/8 inches in diameter.

After making this hole let's make another as near to the switch as possible to accommodate an RSA type record player socket. After the shaft has been sawed to a short length we mount the switch and socket and attempt to wire the units.

We now have our record attachment completed so as to permit maximum performance of both radio and records. In ad-

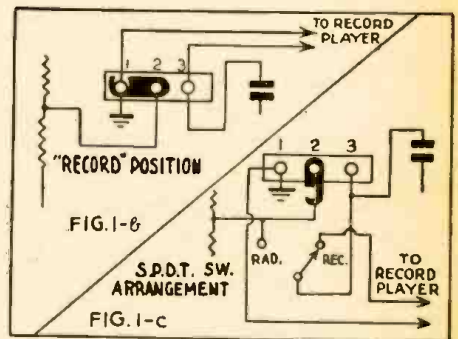

Alternate connections to midget receivers.

dition, the switch and socket mounted in the chassis makes a compact, rigid and neat-looking job. It is a good plan to use shielded leads, and to "ground" the shield.

Another consideration is the arrangement of the leads from the record player. These should be twisted as much as possible so that the ground or chassis lead will act as a shield to the high impedance lead.

It will be noted that the volume control in the set will control the gain in addition to the control already provided in the record player. This is a good feature as the player control can be left wide open and the degree of output desired controlled from the radio. It is also interesting to note that with no signal from the record player, and with both controls at maximum there will be a noticeable hum.

However, when playing records with the controls in this position, the audio system would be overloaded to such an extent as to become unbearable to the ear, therefore requiring either one or the other controls to be turned down to a point where the hum level would be negligible or not heard at all, even with the audio section fully loaded.

It is not necessary under the above conditions to use shielded wire in any part of the circuit. If an extension is to be fastened to the leads provided with the player then shielding would be advisable. Extra-long extensions are not recommended.



**NO PHONO PROVISIONS**

Let's consider the third classification—where no provision whatsoever is made for record players. It might seem at first thought that our problem is somewhat more involved since now we have no terminal strip with which to work. The terminal strip can be disregarded.

This condition is the same as in Fig 1c except that the terminal strip is omitted. The procedure of connecting the player is essentially the same.

In other circuit arrangements, a break must be made in the grid return, so that switching arrangement can be inserted.

**ELABORATE CIRCUITS**

There are of course many other types of circuits designed to perform the same operations as those circuits already discussed, but which are possibly more elaborate and appear more difficult. Most of these "elaborate" circuits can be analyzed as readily as the simple ones, and the record player attachments connected accordingly.

It may be wise to recall that in many AVC and 1st audio grid systems, fixed bias is employed whereby the grids of the RF-IF and 1st audio tubes are supplied by a voltage of negative potential from either the power supply or by those delicate little items called bias cells. These biasing methods should present no great problem when installing record player attachments. However, it is the best plan to look up the schematic of the set before doing any wiring.

Where the RF-IF grids are biased thru the AVC system from the power supply it is permissible to short out this bias where the switch connections are made.

In regard to bias cells in the AVC system, these circuits are usually so designed that when the AVC is shorted at the normal point, the bias cells themselves will not be shorted. Where a diagram of the receiver is not readily available and any doubt arises of the possible results of shorting bias circuits, the shorting should be done through a by-pass condenser of about .05 mfd.

**ANTENNA HOOKUP**

We have discussed satisfactory ways of connecting record players in several types of circuits and have solved the problem of preventing radio reception from escaping into the audio section when playing records by the process of shorting out the audio channel from the diode detector. Our biggest task then was not so much as to make the radio-record player combination workable as to prevent unwanted radio reception. It is time now that we ask ourselves this question—"Can this radio interference be eliminated by other means than those already described?" Why not get rid of it before it ever reaches the 2nd detector? Let us see what can be done.

If a receiver is tuned to a broadcast station and the antenna and ground connections are suddenly shorted, the program to which we were listening will have disappeared. Why not, instead of shorting out the diode detector channel, make our switch connections to the primary of the antenna coil so as to short out any RF present when playing records?

Such a set-up seems to offer a simple solution to our problems; however, there are disadvantages to be considered. For example, some sets have a natural high

noise level, and others are not so well shielded; and the possibility of picking up stations even with the antenna and ground shorted is very great. Also, in such sets, tube hiss, other internal noises and man-made static can be expected.

The chief advantage of the system is its simplicity. This type of hookup nevertheless, can be used to good advantage in some receivers with favorable results. When considering this type of radio-record attachment it will be necessary to do a little experimenting, and in general use some discretion before making any final decisions.

**CONNECTIONS TO I.F.**

What we are really looking for is the simplest and most effective way to connect the record player. The above paragraph described a very simple process but does not

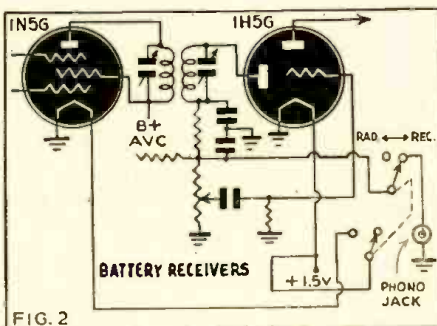

Typical hookup of radio-record switch for battery receivers.

always produce the desired results. The audio connections for the record player are quite satisfactory but the problem of eliminating unwanted radio reception is not entirely solved. So a few suggestions are in order.

The local oscillator could be made to cease operating. The procedure of doing this may not be a simple performance and the results would probably be disappointing. Why not block the IF amplifier? This seems more practical. Which circuit to work on is the next consideration. It would be folly to make any changes in tuned circuits, so that leaves us with untuned circuits.

On examination of a common I.F. system it seems logical that the cathode circuit of the I.F. tube could be opened. This is an easy operation and will make the procedure of connecting the record player a simple one. So much for simplicity.

The next question then is "Will this process prevent radio reception from reaching the audio system?" The answer is "It will."

**BIASED CATHODE**

In a case where the cathode is not connected directly to chassis but rather through a resistor-condenser combination the circuit would be opened at the socket or in ground lead.

Incidentally, this "open cathode" in the IF amplifier is to be preferred to all other systems described in this article. The only disadvantage in using this method is the fact that the cathode connections on the tube sockets of some sets may not be readily accessible because of being covered by wires, condensers, resistors and what not. Servicemen know only too well that the bottom of some chassis presents the appearance of an oversize can of sardines.

If such a condition is found it is perfectly feasible to open the cathode circuit of the converter tube to make the necessary connections, provided the receiver has only one I.F. stage. Should this tube socket prove to be as bad as the I.F., then make all connections in the audio section using the ideas already described.

**AC-DC RECEIVERS**

Up to this point all ideas and illustrations have concerned A.C. superheterodynes with diode detection. AC-DC sets require special attention. As is well known (and sometimes temporarily forgotten) by servicemen, many AC-DC radios have a B minus network that is not of the same potential as the chassis. In other words the B-minus is separated from the chassis by a tubular condenser or a condenser and resistor in parallel. A condition such as this must be strictly observed when making record player connections. Be sure to make all ground connections, ordinarily made to the chassis of an AC set, to the B-minus of the AC-DC set and not to chassis. When installing the switch and socket in the back of the chassis it will be necessary to insulate the ground side of the socket from the chassis. Some AC-DC sets are equipped with a cabinet back made of wood, cardboard or other material and the units could be mounted here instead of in the chassis. If this is done keep these units as near the chassis as possible. The main thing to remember is the B-minus, for correct or incorrect connections will mean success or failure.

Of course all AC-DC sets do not have the B-minus above chassis and in a great many cases the B minus is chassis. In such an event the connections would be the same as for an AC set.

**BATTERY SETS**

Battery sets are as adaptable to record players as are the power line receivers, and many manufacturers have put on the market record players expressly designed for use with battery radios. These have a spring motor and the usual crystal pickup.

To make the correct phono connections the "open cathode" system is used to eliminate radio reception, and the audio connections are likewise the same. However, battery-type tubes have no cathode (the filament itself acts as the cathode), so instead of opening an actual cathode we open the filament of the I.F. tube as in Fig. 2.

**AC-DC-BATTERY PORTABLES**

These sets are usually designed with the filaments in series. The I.F. tube will be of the battery type with no cathode and we cannot break the filament circuit as this would cut off the filament supply to the other tubes. Therefore all wiring will have to be done in the audio section using the ideas outlined in the first part of the article.

**POWER DETECTORS**

Occasionally you will be asked to install a record player attachment on a superhet with biased or power detection, or a T.R.F. receiver with power detection.

In this instance an entirely different problem arises.

Here the problem is no longer: "How to get rid of unwanted radio reception?" but rather "how to connect the record player in the circuit and where?"

If the grid circuit at grid is broken and

(Continued on page 238)



# 1-TUBE INTERPHONE ON A.C.-D.C.

By ARTHUR BLUMENFELD

**T**HE OUTSTANDING feature of this inter-office communicator is its simple and foolproof design. The use of a design in which only 1 tube is necessary in each station, results in a unit of small size and few parts. Only 2 resistors are used in each unit!

## ADVANTAGES OF "DIVIDED GAIN"

The construction of the unit is very simple, due not only to the few parts necessary but also to the stability of the design. The use of "divided gain" eliminates the possibility of oscillation which is often encountered in the high-gain type of intercommunicators. The 1-tube interphone also has other advantages over the usual type of system. The use of "divided gain" makes possible the calling of an unlimited number of stations without loss of either power

or clarity. There are also unlimited possibilities as to multi-station break-in. That is, any group of stations may hold a conference without the use of additional switches, such as are necessary with the usual systems.

amplifiers are in cascade in order to give the required amount of amplification. The total amount of gain is "divided" equally between the 2 stations.

The total gain of the entire system is about 70 db. With the usual type of intercommunicator, to attempt to build a compact unit results in a design which is quite critical as to circuit oscillation. Any slight deviation from the original design in regard to placement of parts or method of wiring, may result in uncontrollable oscillation. However, by dividing the gain equally between the units, we have only 35 db. gain to contend with. It is practically impossible to run into any trouble, no matter what the arrangement of parts. The method of wiring is also not critical, as long as the circuit is followed correctly.

It might be mentioned also that there are some disadvantages in the simplified system of the 1-tube intercommunicator. There is a slight hum when transmitting, due to the use of a power-type tube as the first tube in the amplifier. However this slight hum does not interfere with the clarity of the speech, and is not annoying. In the "stand-by" position the units are silent, without any background noise.

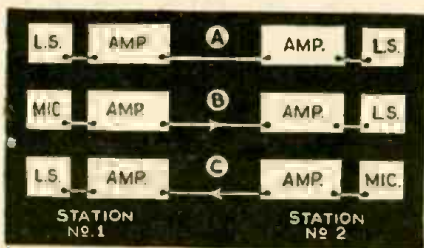

Fig. 1—Status of units when (a) "standing by"; (b) talking and (c) listening.

In order to understand the principle of operation of the 1-tube intercommunicating system, examine the 2-station type which is shown in simplified block diagram form in Fig. 1.

In Fig. 1A station No. 1 and No. 2 are shown in the "stand-by" position ready to receive messages from each other. In Fig. 1B station No. 1 has "thrown" its switch to the send position and is talking to station No. 2. When station No. 1 releases the switch, both stations are again in stand-by position and station No. 2 talks to station No. 1 as shown in Fig. 1C.

Notice that during transmission, the 2

## CIRCUIT ANALYSIS

The schematic circuit of a single unit of a 2-station system is shown in Fig. 2A. In installing the system, a 2-wire cable (with plug and socket connections) is run from one unit to the other. Each unit uses a 12A7 type tube which consists of a half-wave rectifier and a high-gain power pentode.

Note that the rectifier system does not use a choke for filtering. The 2,000-ohm resistor, R2, provides adequate filtering without causing excessive voltage drop. This is due to the fact that 12A7 draws only 15ma.

Switch Sw. 1 is a double-pole-double-throw unit of the press-to-talk type. This means that it should contain a spring to return it to the "listen" position. Of course an ordinary D.P.D.T. toggle switch may be used, but this is more difficult to manipulate than the spring-return type.

Input transformer T1 is designed to feed from a 4-ohm line into a control-grid. The output transformer, T2, is of the universal type with the full winding used as primary

and taps 2 and 5 for the 4-ohm secondary. By shifting the taps of this output transformer, variations in tone may be effected. In general, however, the 2 and 5 taps will be found best.

The bias for the 12A7 is obtained from the voltage drop across a 1,000-ohm resistor, R2, shunted by a condenser C2 which is a 10-mf. electrolytic. Note that the "B"-minus return does not ground directly to the chassis, but is connected to a 0.1-mf condenser, C3, which goes to the chassis. This serves to isolate the power line from the 4-ohm voice line. The resistor, R3, situated in the line cord, is 360 ohms. The speaker is a 3-in. P.M. (permanent-magnet) dynamic type. Switch Sw. 2 is a single-pole single-throw rotary switch.

## 7-STATION SELECTIVE OPERATION

When more than 2 stations are necessary, the circuit of Fig. 2B should be used. An examination of this circuit shows that a 7-switch, Sw.3, has been added. Also an octal-type socket has been substituted for the 5-prong socket. We can now install 7 of these units as a selective intercommunicator. The 7-point switch allows us to select any one of the other 6 stations with the last point used as an "off" or "stand-by" position.

The complete interconnecting wiring diagram of the 7-station intercommunicating system is shown in Fig. 3. The materials required consist of an 8-wire color-coded cable (of sufficient length to pass through all the rooms in which the stations are to be installed), and 7 octal-type plugs.

The best method is to install the cable all in one piece, allowing about a foot of slack at the points near where the units are to be installed. If splicing is necessary, the cable color code indicates the proper connections. If the colors of the cable do not correspond to those of Fig. 3, the correct colors must be noted on the diagram in order to prevent confusion.

The 7 octal plugs Pa, Pb, Pc, etc., of Fig. 3 are connected to adequate lengths of 8-wire cable as shown. The color code of all should be identical and are to correspond to that of the main cable to which the plugs connect. In connecting the plug cables to the main cable, simply skin back the wires, make the proper connection (solder

Fig. 2 A—Diagram for 2-station system; B—Diagram for multi-station system.

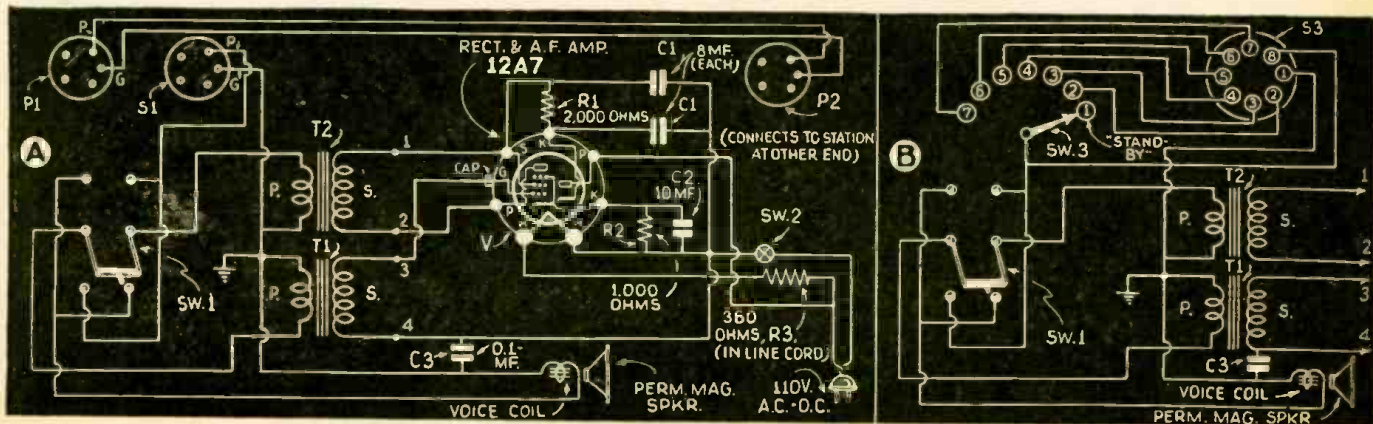



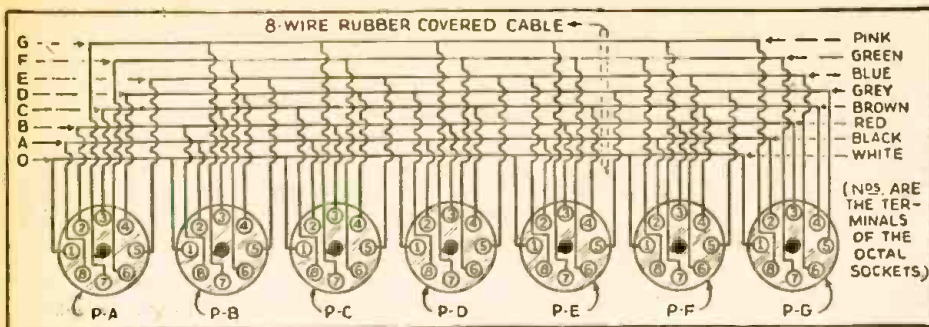

Fig. 3—Circuit for either selective and semi-private, or (position "O") "conference" communication.

all connections), and tape each individually. These connections are made at the points where slack was left in installing the cable. For the sake of appearance the cable junction should be covered with a small box. Note that Plugs Pa and Pg may be connected directly to the ends of the main cable. The next step is to insert the 7 plugs into their respective units and plug the line cords of the units into the A.C. or D.C. line. The system is now ready for operation.

The indication of the outlying stations

position. When station "A" is finished talking, station "B" need only press Sw.1 in order to answer. This feature of the system saves much time because in the usual interphone, station "B" would have to know from what station the call had originated in order to reply.

THE "CONFERENCE" CIRCUIT

If station "A" wishes to have a conference with stations "B" and "C" simultaneously, he calls them each individually

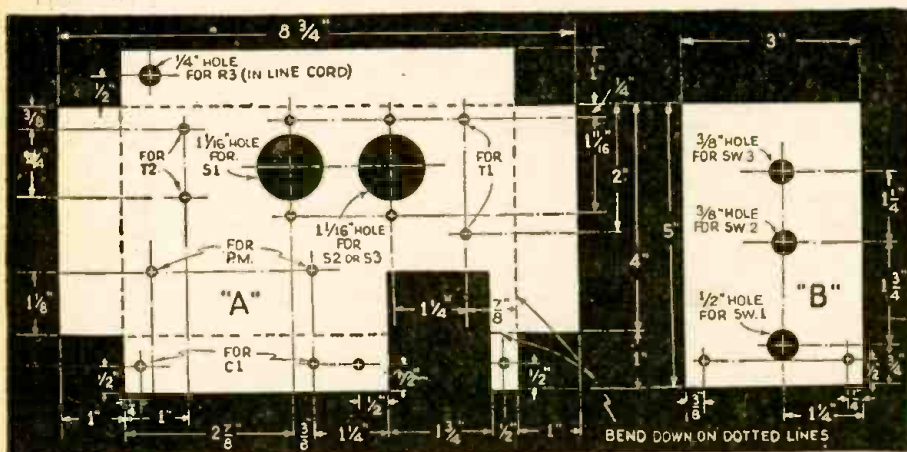

Fig. 4—Chassis and front cover details of the one-tube interphone.

on each unit may be made by studying Fig. 2 and Fig. 3. Thus on station "A", the pointer knob of switch Sw.3 indicates as follows:

- Point No. 1 ..... "off" or "stand-by"
- 2 ..... to station "B"
- 3 ..... to station "C"
- 4 ..... to station "D"
- 6 ..... to station "E"
- 7 ..... to station "F"

The dial markings of station "B" are similar, except that point No. 2 indicates station "A" instead of "B", etc. The operation of the system is as follows: All stations are normally on point No. 1 or "stand-by". If station "A" wishes to call station "B", the knob of Sw.3 is thrown to "B" position and Sw.1 pressed for the "call"

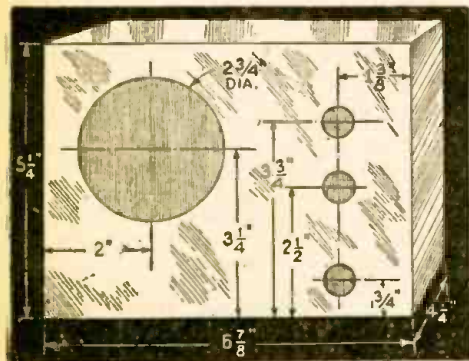

Fig. 5—Front-panel drilling layout of the one-tube interphone.

and asks them to get on his line. A 3-sided conversation is then possible. This may be also arranged for any number of stations. Even while talking to all 6 outlying stations there is no loss in either volume or quality. This is due to the design whereby the voice is transmitted to a load which absorbs a very small amount of power. In the usual type of intercommunicator, the power delivered is in inverse ratio to the number of speakers on the line.

While the system described was for 7 stations, any number of stations may be arranged for by means of slight changes. For instance, if a 3-station system is desired, only a 4-wire cable between stations is necessary. Only that portion of Fig. 3 which includes Pa, Pb, Pc, need be used. For more than 7 stations, the number of points of Sw.3 must be increased proportionately, and the cable likewise. Also binding post strips will be necessary instead of the octal sockets used. (The constructor may wish to try the recently-announced type 25A7G, 25-V tube—not as yet available to the writer—if increased amplification is desired.)

CHASSIS DETAILS, AND WIRING

In constructing the units, we first make the chassis as shown in Fig. 4. The main part of the chassis is formed from a piece of No. 16 gauge aluminum as shown in Fig. 4A. All holes are made with a No. 28 drill unless otherwise indicated. Next to, or in between the pairs of holes is indicated the

(Continued on page 256)

# RADOLEK— Headquarters For Essential REPAIR PARTS



Thousands of progressive servicemen rely on Radolek for their complete requirements of repair materials. Make Radolek your dependable source for essential replacement and repair parts—tubes, condensers, volume controls, resistors, transformers, etc.—all at lowest prices.

Radolek understands service problems—gets delivery to you in double-quick time. Buying from Radolek means Greater Values, Better Service and More Profits. The big Radolek Radio Service Guide is FREE for the asking. Send for your copy today!

## RADOLEK P. A. SYSTEMS FOR EVERY REQUIREMENT

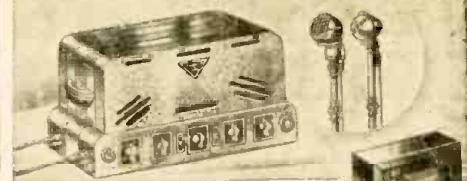

Thousands of successful Radolek P.A. installations are proof of quality, superior design and top performance. Complete systems for permanent, portable or mobile use—wide choice of microphones, speakers and related equipment. Radolek P.A. Systems give you more for your money in Performance, Styling, Dependability and Reserve Power. Select the P.A. apparatus you need from Radolek's big FREE catalog.

RADOLEK REPAIR SERVICE

Let Radolek repair your damaged or burned out transformers, coils, speakers, test equipment, etc. Many items cannot now be replaced and therefore repairing is the only alternative. Trained craftsmen, using precision tools and factory methods, assure perfect jobs equal to new. Write for prices or better still, send in any article to be repaired. It will be handled promptly.

FREE!



SEND FOR NEW FREE RADIO SERVICE GUIDE

RADOLEK CO., Dept. C-74  
601 W. Randolph St., Chicago, Ill.

Please send the Big FREE Radio Service Guide.

Name .....

Address .....

DEALER  SERVICEMAN  SOUND ENG

SAVE AT RADOLEK



# AUDIO SCALE FOR BLIND

THE "audio" scale, making it possible for the blind to weigh rapidly and accurately, and opening new industrial fields to them, was demonstrated last month at the Ameri-

an unbroken buzz.

The suggestion for such a scale was originally made by a blind woman in Buffalo, and the device was developed by the scale engi-



The photo shows (center) Mrs. Jane Muhlfeld Barbour, who has been blind from birth, seated before the new "Audio" scale in much the same manner that a blind operator would in an industrial plant. On the left is J. O. Kleber, Chief Engineer of The American Foundation For the Blind; and (right) Lawrence Williams, Chief Engineer of the Toledo Scale Company, who developed this new device.

can Foundation for the Blind in New York City.

The scale operates on the airplane radio beam principle, giving the audible signal "A" as long as the scale shows "under" the correct weight, and the signal "N," if it registers "over." Correct weight is signalled by

neers with the encouragement of the Foundation.

In war plants, the scale has such uses as weighing out specific amounts of powder for fuses, mica for radio mechanisms, and but-

(Continued on page 249)

## OPTICS AND ELECTRONICS

(Continued from page 205)

practical, but where it is practical there is usually great demand for it and the electronic control under such conditions does the job better than any other method.

An example of real utility is the use of this modern method in conjunction with the welding process. In Fig. 9, if transformer TG should open circuit, T1 and T2 will be non-conducting. This is the result of having the large A.C. voltage (in phase with the anode) superimposed upon the D. C. bias potential. Anode output of the tubes, through the series power transformer, controls the power supplied to the welder transformer. When those tubes are non-conducting, there is a small exciting current flowing, but when the tubes are conducting a negligible reactance is presented by the transformer.

A bias is applied to the grids to make the vapor discharge tubes completely non-conductive, being secured (the bias) from the full-wave rectifier tubes, T7 and T8. Their output is filtered by the R3, C3 components, and resistor R7 limits the grid current when the grid is positive with respect to the cathode. The function of C2 is to increase the grid-cathode capacity. Condenser C2 and the resistance (with a negative resistance current characteristic) across the secondary of the series transformer—assure that the tube will not lose its control of voltage surges and will not relinquish that control to the welder.

If the control over the welder is to hold satisfactorily, a necessary condition is that minimum current be drawn and not heavy transients in the supply line. Also, the D.C. components must not be allowed to saturate the core of the transformer, a requirement that dictates accurate timing and the employment of a timing device that cannot be connected directly to the power tube.

The control circuit uses the same principles used in the power tube arrangement, but without transformer coupling, for tubes T3, T4, are directly in the the A.C. supply lead to transformer TG. Tube T3 is a three-element type. Tube T4 is a four-element tube, selected for the reason that it can positively be controlled with minimum power. By using it, the limiting resistance (R) can be made high in value, which reduces the load on the timing circuit. A further advantage of this tube type (four element) is that its characteristics change very little with temperature.

In the event that timing could be introduced directly into the grid circuits of T1, and T2, without too great a power drain, the control circuit stage could be cut out. The timing circuit includes the elements TR4, T5, R5, R1, R2, R6, C1 and TR6. This circuit behaves as a limiting reactor, to limit the peak value of the discharge current of T5 and also acts as a part of the lockout circuit. The impulse circuit is regarded as an inverter and is used to perform the timing job for the welder. Controlled by the peak A.C. voltage the pulsating inverter is exactly synchronized at an even number of halfcycles of the A.C. power supply.

Length of the welding cycle is set by length of time required to charge C1, in the timing circuit, to a critical value, and the length of time that the current flows depends on what period of time the grid of T4 is positive during the cycle. The setting of resistor R1 determines the first, and the relative value of R2 determines the second. A simple system for adjusting the welder operation is formed by R1 and R2. The

(Continued on page 249)

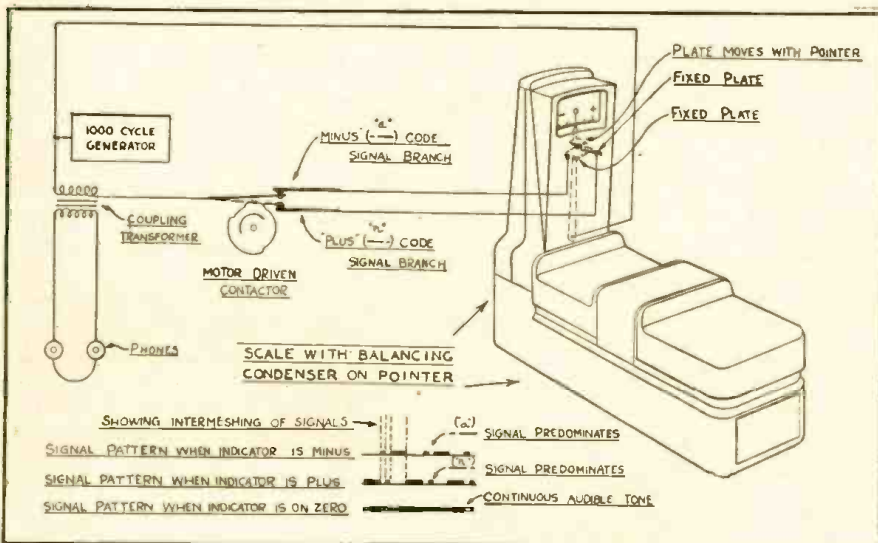

A 100-cycle tone generated in the oscillator flows in the tunable double-branch circuit, with an earphone transformer coupled commonly to both branches. A motor-driven contactor switches the current from one branch to the other, alternately, so that the intermeshed "A" and "N" pulses are applied respectively to the "minus" and the "plus" fixed plates of the scale-indicator balancing condenser. At the desired weight, both signals are heard synchronized.



# REMOTE MIXER

IN ORDER to realize the most effective and most pleasant reaction by an audience to a P.A. system it must be constantly "monitored" from a point of vantage in the audience. This, of course, calls for a remote control system of "fading" and "mixing" the input circuits of the amplifier.

Until recently, however, such a system

## 1612 TUBE AFFORDS CATHODE-CIRCUIT VOLUME CONTROL

The amplifiers with which this remote mixing unit is used have 2 separate input channels. Each channel has provision for phonograph and microphone input. Mixing of these input channels is not done in the signal circuits but is accomplished in the cathode circuits of the input tubes.

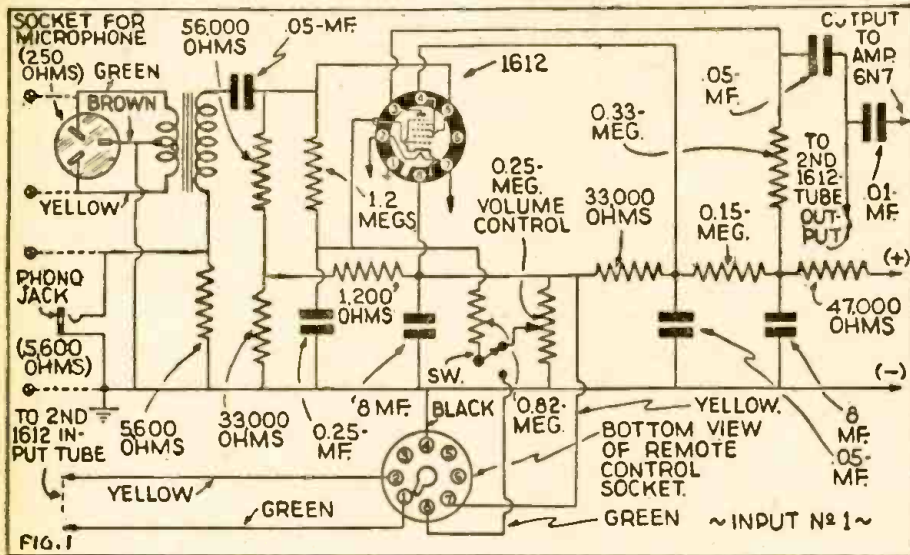

FIG. 1  
Circuit diagram of the remote mixer for P. A. work. Although it is simple and compact, it depends for its operation on a special type tube, the 1612. The illustrations show how the remote mixer is used.

was impractical due to the difficulties introduced by the distributed capacity of the long cables, etc. Now, however, it is possible to accomplish this remote mixing, up to 2,000 ft. from the amplifier, through the medium of a compact portable unit small enough to be held in the hand. This of course is a highly desirable feature, seldom offered in P.A. equipment of any type. It has been adapted to the public-address systems of a well-known large manufacturer.

The 2 potentiometers on the remote-control head are wired into the cathode circuits of the RCA type 1612 input tubes. Thus no losses in signal are introduced by the long, remote-control cables. Since the remote potentiometers are not in the signal circuits, remote volume control and mixing may be accomplished at any distance (up to 2,000 ft.) from the amplifier, and this may be done permanently or temporarily.

The changeover to remote mixing is ac-

(Continued on page 248)

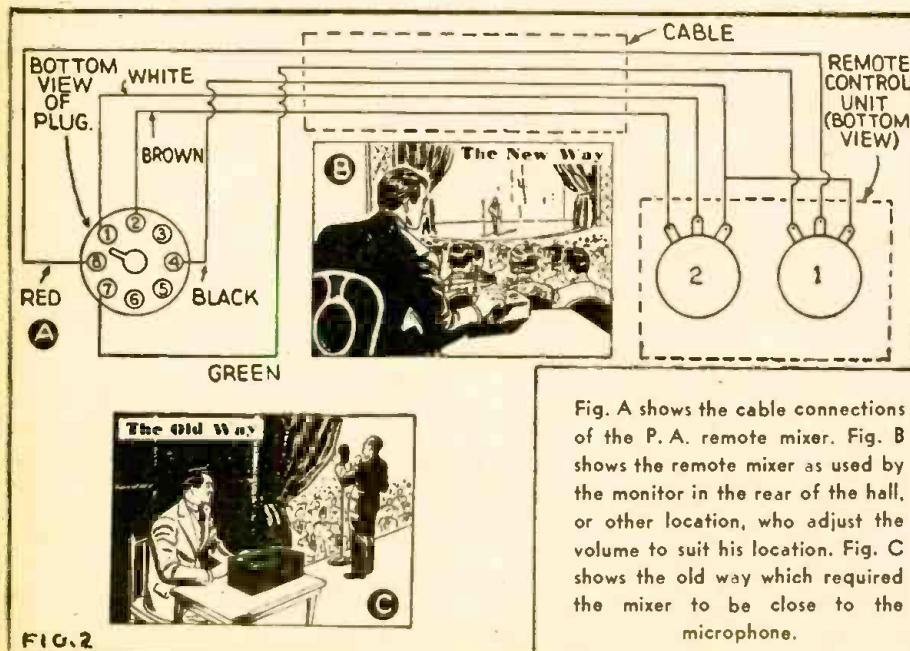

FIG. 2  
Fig. A shows the cable connections of the P. A. remote mixer. Fig. B shows the remote mixer as used by the monitor in the rear of the hall, or other location, who adjust the volume to suit his location. Fig. C shows the old way which required the mixer to be close to the microphone.

## SPRAYBERRY RADIO TRAINING FULL EQUIPMENT

Experience Easily Acquired at Home



You Do Practice - Giving Experiments. Many Special Features. ALL Designed to Help You Make Fast Progress

### SPRAYBERRY

Training starts right at the beginning of Radio. You are introduced to each subject in a simplified, logical, understandable style. You easily learn Television, Frequency Modulation, Signal Tracing, Mobile Radio (Auto-Tank), Aviation Radio, Electronics, Facsimile Radio, Radio Set Repair and Installation Work.



Training Prepares You for a Business of Your Own... or Good Radio Jobs—Civilian or Military. The important and fascinating field of Radio offers many opportunities to the man who wants to get ahead. My Training will help you win quick promotion in the Army or Navy... will fit you for a bright Civilian career. SPRAYBERRY Methods are thorough and practical. Your Training will not interfere with your present duties. No previous experience is needed.

You Get a Dual-Purpose Radio Set. I supply you with Radio Parts which you use to gain pre-experience in Repair work. These same Parts are used as a Modern Signal Generator and for Signal Tracing, etc. You'll find my Course and Equipment fully described in the catalog offered below.

Earn While You Learn. My BUSINESS BUILDERS show you how to put your equipment to actual use in handling money-making Radio Service Jobs shortly after you begin Training. THE SPRAYBERRY COURSE IS SOLD UNDER MONEY-BACK AGREEMENT.

RUSH COUPON for BIG FREE BOOK

SPRAYBERRY ACADEMY OF RADIO  
F. L. Sprayberry, President  
620-A University Place, N. W.  
Washington, D. C.  
Please send me FREE copy of "HOW TO MAKE MONEY IN RADIO."  
Name ..... AGE .....  
Address .....  
City ..... State .....  
(Mail in envelope or paste on penny postcard)

## READ and SEND CODE

Learn Easily at Home This Quicker Way

No experience needed. Beginners read code quickly, copy accurately. If already an operator, speed up your spin with this approved amazing all Electric Master Telex Code Teacher. Only instrument which records your sending in visible dots and dashes on specially prepared paper tape—then sends back your own key work at any speed you wish. NO PERFORATIONS—NO INK. Far superior to anything ever developed. Fascinating, foolproof—gets results because you learn by HEARING as well as SEEING. That is why thousands agree this method is surest and quickest. While not designated standard equipment, Telex is used at many U. S. Army Posts, Naval Training Stations. We furnish Complete Course, lend you the New All Electric Master Telex, and personal instruction with a MONEY-BACK GUARANTEE. Low cost, easy terms. Write today for folder S-1; no obligation.



107 HUDSON ST., JERSEY CITY, N. J.

## Webster DeLuxe Mixer Changer

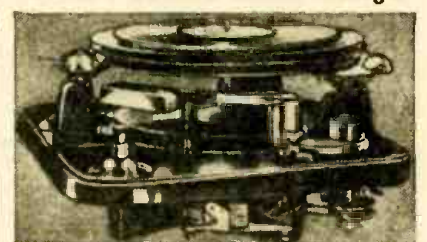

Plays from 14 to 18 Records. Lightweight Lifetime needle. Crystal Pickup. Automatic Shutoff on last Record. 13 1/2" x 17" — 5 1/2" above plate, 4 1/2" below plate for 110 volts A.C. 60 cycles. Shipping weight 30 lbs.

\$45.95

ARROW RADIO, INC.  
82 CORTLANDT ST., N. Y. C.



# THE "SIMPLICITY-1"

By HUGO GERNSBACK

*A development of the war, the author of this article demonstrates that it is possible to construct a radio set practically without the use of strategical materials. At the same time, a new radio principle—"CAPIND"-tuning—is introduced by the author.*



*While the present receiver has purposely been built as a "How to Make It" model, the author stresses the point that the new principle is certain to be used in post-war radio sets, as it does away entirely with variable condensers, used almost exclusively heretofore as a means of tuning radio receivers.*

**T**HERE are several ways by means of which a radio receiver can be tuned. The original wireless receivers of the olden days were tuned without a condenser; merely by using a slider. This was quite satisfactory to vary the inductance as long as a crystal detector was used. As soon as the vacuum tube was invented, sliders quickly fell into disuse on account of the noises which they created in the audio end of the receiver.

Still another way to tune a radio set is by means of a variometer. This also has its limitations, particularly when vacuum tubes are used, because it is difficult to obtain the

correct wave length by means of a variometer.

Still another tuning means is by using a loose coupler. This again is not very satisfactory for vacuum tube circuits because of the switching arrangement necessary to obtain the different wave lengths, as well as the inherent noises produced in the ear-phones or loud speaker when tuning the loose coupler.

This brings us to the more recent means of tuning with which we are all familiar—namely, the variable condenser. If a single circuit is used, only one condenser is employed. Where three tuned circuits are em-

ployed (such as in superheterodynes, etc.), a triple or ganged variable condenser must be used.

One of the newer recent developments is a (condenserless) tuning system whereby finely divided iron cores are used; by sliding such an iron core in and out of the inductance, tuning is achieved.

The new system which I am about to describe differs from all of the former methods. The "Capind" (a new word coined by joining the words "capacity" plus "inductance") system, as its name implies, combines tuning inductance and condenser, all into one component.

Let us see now how the "Capind" system works in practice.

We first have a long and rather slim inductance wound with fine wire. The wire may be wound on a cardboard tube or other insulator, or a solid wooden stick, such as a dowel, etc. To achieve tuning, we employ a sleeve which can be of cardboard, paper, plastic or any other suitable substance, which sleeve slides over the inductance. **FOR BEST RESULTS, THIS SLEEVE MUST BE EXTREMELY THIN.** On top of the sleeve, we have a slotted metal conductor, such as tin foil, wrapped around the sleeve. It is highly important to note that this metallic jacket must be slotted. It must not overlap, because the ensuing hysteresis effects will greatly weaken the signals. This then is not just a "losser" arrangement, because the electro-magnetic lines of force are not confined completely within the inductance when the metal jacket is slipped over the inductance, but some of the magnet lines of force still escape, as shown in the illustrations.

Final arrangements have not as yet been concluded to ascertain the exact theoretical

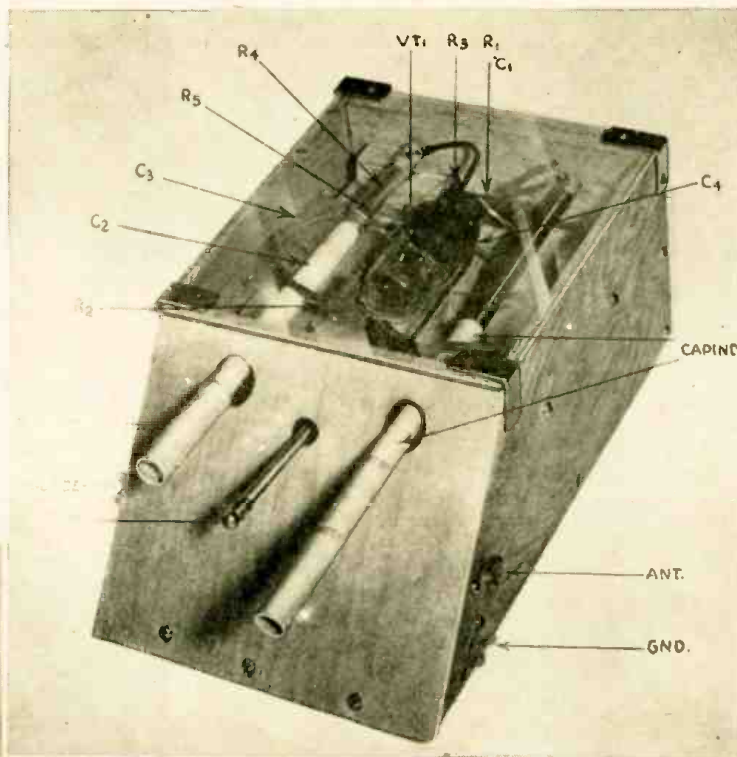

The values of all the lettered condensers and resistors in the above photograph may be found by referring to the schematic diagram printed on Page 243.

## THE "SIMPLICITY-1"

The young lady is shown adjusting the throttle condenser. The other white cylindrical tube is the Capind, and the dark rod in the center is the filament switch. The headphones are connected to a pair of Fahnestock clips similar to the Ant-Gnd clips, one of which may be seen projecting beyond the edge of the case. The front of the cabinet may be removed to change "A" batteries, the side for changing "B's."





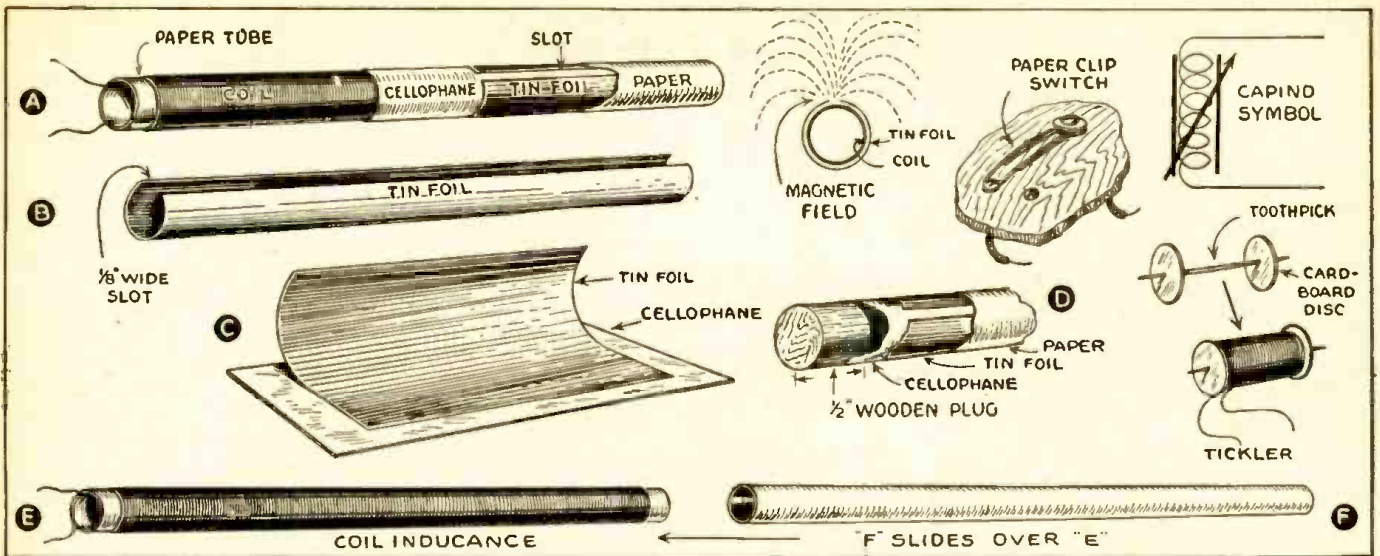

A.—The CAPIND, cut away to show construction. Note the slot and the protective projection of cellophane beyond the end of the tinfoil tube. B.—Tin-foil capacity plate as it would appear in position. Note how cellophane projects beyond edges. D.—Cut-away of the hand-grip end. Tinfoil stops short of plug, to prevent hand-capacity. E. and F.—Inner and outer sections of CAPIND.

and practical width of the slot necessary for best operation, and quite a good deal of research work remains to be done. We did, however, experiment with a number of sleeves, and the one selected in the present model of the "Simplicity—1" receiver seems to give optimum results for this particular inductance.

That the air slot of the metal sleeve is all important was quickly demonstrated when by mistake my original instructions had not been carried out correctly, for the first design had a spirally-wound tin foil sleeve which, even though it was insulated so that the metal edges did not touch, gave poor results, because there were no means for the magnetic lines of force to cut through the metal sleeve.

"Capind"-tuning is accomplished simply by pushing in and out the movable sliding member which fits over the inductance, and the set thus tunes the same as other sets.

As the "Simplicity—1" is a regenerative set, the means for regeneration are had by sliding back and forth a home-made type of variable condenser which can easily be made by anyone without special tools or machinery. This particular type of tubular slide condenser is not very new, as similar types of condensers have been used since the old days of wireless. It was selected simply for the "Simplicity—1" to keep everything as simple as possible, so that anyone could build the set with a few spare parts found almost anywhere.

Indeed, the purpose of the "Simplicity—1" radio set was merely my idea to demonstrate that even with the great scarcity of radio parts at the present time, it will still be possible for anyone with ordinary tools of the simplest kind to build a workable radio set that brings in the stations loud and clear.

With the exception of the radio tube and batteries, the rest of the radio material in the "Simplicity—1" costs less than \$1.00—believe it or not.

This again demonstrates what I have often said, that with a little ingenuity most obstacles can be overcome; and as necessity is the mother of all invention, it may be said that the "Simplicity—1" came to life just on account of this.

Of course the "Simplicity—1" can also be built on a breadboard, if you do not wish to use the box arrangement shown in our illustration. It was thought best to incorporate the entire set in a box, as illustrated, and the glass window on top has been added merely so that the unusual tuning means can be followed visually.

The present set works well and brings in practically all stations with good volume, some of them strong enough to work a loud speaker on the nearer local stations.

The calibrating is done as shown in the main illustration, stations being written on the outer paper sleeve where they pass the circular hole in the slanting wood panel.

The first model is a portable battery-operated set. Due to the present scarcity of batteries, we will present in the next issue another model of the *Simplicity* receiver—electrified.

**FUTURE CONSIDERATIONS**

I am certain that the new "Capind" principle will be embodied in many receivers of the future. The reasons why I believe this to be so are the following:

1. The cost of the expensive aluminum variable condenser, or condensers will be saved.
2. While in the first model the tuning method is, of course, crude in that it is nec-

essary to pull the sleeve in and out, future factory-made sets will not be so hand-capped. The present motion can, of course, be translated by means of a simple lever arrangement so that an ordinary knob can be used for tuning; or, if desired, we can have a long horizontal scale, as is now prevalent in many radio sets—the tuning still being done by the knob method.

3. The "Capind" principle can, of course, be incorporated into a "gang," so that two, three or more Capinds are all moved simultaneously as is now done with ganged condensers, or ganged powder-iron cores.

4. The size of the Capind can be shrunk to very minute dimensions by using special bank wire-wound inductances or other forms of special inductance windings. Thus, for portable sets, such an inductance will shrink down to less than one inch in length, if necessary.

5. The usual assembly costs of a receiver are greatly reduced by using the Capind principle, and a great deal of valuable space is saved. This is especially important in portable receivers.

6. Finally, the weight of the radio receiver is reduced by using the Capind construction, as the set can be smaller in dimension. There are no condensers or heavy iron cores, the latter not being very practical in small portable sets anyway.

To sum up, it seems that there should be a very bright future ahead for the "Capind" principle.

I wish to express my thanks to Fred Shunaman who carried out my ideas incorporated here and who did a great deal of the preliminary experimental work. He also constructed the first model of the "Simplicity—1" receiver described on page 222.

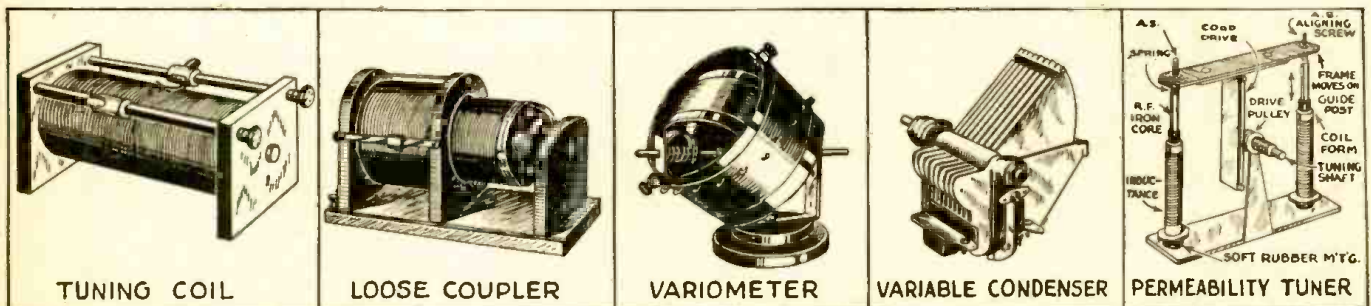

Pictorial history of tuning means: two-slide tuning coil, used in the earliest period; the loose-coupler, king of the wireless days; variometer, popular in the early twenties; variable condenser, one of the oldest and most widely-used tuning devices; and the recent permeability tuner.



# CONSTRUCTING THE "SIMPLICITY-1"

By FRED SHUNAMAN

**M**ANY years ago—in 1922 to be exact—I was an ardent reader of the Gernsback magazines. The Gernsback editorials were my favorite reading. But when about the end of 1923, Hugo Gernsback came out and predicted in a *Radio News* editorial that soon we would have "single-knob" receivers, the flame of my faith wavered and went out. (At the time I was toying with the idea of buying a Federal, a beautiful job with 11 controls.) The idea of a one-knob single-control set in 1923 was more than preposterous—it was downright idiotic! The man must know that the more controls, the greater control over sensitivity and selectivity! I continued to read *Radio-News*, but scanned the editorials with a suspicious eye—I had learned that the Editor was ready to sacrifice scientific fact for the sake of sensational prophecy.

Now that the single-control radio has become universal, I am more ready to believe that anything is possible in radio. So when Mr. Gernsback first asked me to carry out his idea on the "Capind" tuner, I was able to overcome my natural skepticism. It didn't look practical, and I felt that if there were anything in the idea, it would have been worked out in the 1922-26 period of experimentation. Nevertheless, I went ahead, following instructions as closely as possible, and the results are shown here.

## NO MORE PARTS

The war has clamped down on the home radio constructor. Parts—even for essential jobs like WERS receivers—are often impossible to obtain. No new ones are being manufactured for civilian use, and stocks are dwindling toward the vanishing point. Constructors boast of a job successfully completed "with the last 100-mmfd. variable in Kansas City."

Yet there are many war uses for the small set. It may be used as an "alert" receiver for air-raid information. Constructed especially for the job, it is less expensive to operate and wears out fewer valuable and unreplaceable parts than does the large broadcast receiver. As "alert" receivers are operated 24 hours a day, this is important. The small set may be used in makeshift observation posts on roofs, etc., to keep in touch with local broadcasts. Tuned to the local police band for example it may serve the voluntary patrols.

The need for such sets challenges the earnest constructor to master the difficulties created by the parts famine. They are far from insurmountable. We are informed that tubes—in certain standard types—will continue to be available for the duration. As other parts become unobtainable, they must be made by the constructor himself. Old-timers remember well the days when we made our own book-type or slide-type variables, copper-foil and mica fixed condensers, pencil-mark grid-leaks. Some tell tall tales of amateurs who constructed their own vacuum tubes!

With all this in mind, it was decided to construct a "Simplicity Receiver" which would entirely dispense with the present type variable condenser (which is almost 100 per cent constructed of aluminum, brass or other valuable defense metal), would use

as few commercial parts as possible, and would make provision for substituting even these, with home-made components, as the supply of factory-made parts becomes depleted.

A number of ways of doing this comes to mind. The variable condensers may be supplanted by variometers, or by condensers with tinfoil-coated card or thin fiber plates and mica dielectric. Foil may be used for the book-type condenser familiar in the early days of broadcasting, or even in the still more ancient tubular slide condenser.

Other specifications which the set should fulfill are: Use of as few tubes or other parts as possible; reliability, *simplicity* and compactness. A two-tube set is essential for good headphone volume on short temporary antennas.

Fortunately there is a double triode which will continue available—the 1G6-GT. This gives us a 1.5 volt tube equivalent to two single-purpose tubes. The 1E7 would have been better for the purpose, but its manufacture has been discontinued, and is hard to get.

The circuit chosen is the standard "regenerative detector one-stage audio," selected because it gives results almost equal to the trick circuits sometimes used in one-tube sets, and is far more manageable and reliable than any of these.

## MAKING THE "CAPIND"

The "Capind" whose theory is described in the first part of this article, was constructed as follows: A tube was made by wrapping stiff writing paper round a curtain rod. The resulting cylinder, which was  $\frac{3}{8}$  inch in diameter and  $6\frac{1}{2}$  inches long, was soaked in melted paraffine wax, hot enough to drive out all moisture and leave an excellent low-loss form. Then a piece of thin tin-foil, six inches long and  $1\frac{1}{8}$  inches wide, was cut. A piece of cellophane 8 inches long and  $1\frac{1}{2}$  inches wide was cut, laid on a smooth desk, and covered with a very thin coating of coil cement.

The piece of foil—previously carefully smoothed out, was laid on top,  $1/16$  inch from the edge and  $1/4$  inch from one end, and rubbed from the center out, the pieces being turned over as soon as the cellophane adhered, and the squeezing continued to get all air bubbles out and make an absolutely smooth connection between the foil and cellophane. Figure 2 shows the sheet as it was before rolling.

The coil form was now wound for a length of 6 inches with No. 33 enamel covered wire. (The number of turns totaled 750.) The ends of the winding were brought inside the tube, and every care taken to keep the winding even and smooth. Then the tin foil-cellophane sheet was wrapped snugly round the coil, cellophane side "in." A little coil cement was applied to the overlap and the extra tinfoil wrapped on. We then had a cylinder which was foil outside and cellophane inside.

This tube was then again wrapped with several turns of heavy writing paper, cut short enough to allow the tinfoil to project  $\frac{1}{2}$  inch at the end where the cellophane

projects the shortest distance ( $\frac{1}{4}$  inch). This is for connections.

A wooden plug was cemented in the other end as a hand-grasp. The tube was made to fit very snugly over the coil—experience showed that any looseness caused a great drop in capacity.

## THE THROTTLE CONDENSER

A discarded tinfoil tube from an experimental "Capind" was used as the throttle condenser. The inside tube was made by cementing a piece of tinfoil to paper, rolling it up and inserting it into the larger tube while the cement was still wet and expanding it with a knitting needle to fit the cellophane inside wall of the outer tube. Of course the tinfoil of the inside tube was outside its paper form, so that only one thin layer of cellophane separated the two metal sheets. Waxed paper was rolled up inside the inner tube while hot and expanded in the usual manner. When cool, the hardened wax gave the cylinder necessary rigidity.

There is no reason the condenser should not be built up in a more logical manner: say first making the inner, then the outer cylinder. There were a number of unsuccessful outer tubes from the "Capind" on hand—that is why we chose the method used. Contact was made to the units by winding a thin strip of tinfoil around the bare end of the cylinders, then wrapping flexible lead around and into the tinfoil strips.

The tickler circuit had to be worked out to fit the peculiar shape of the "Capind." It started out as a regulation condenser feed-back circuit. Because of the length of the tuning coil, coupling was weak. If enough tickler was used to give satisfactory regeneration at the low-frequency end of the band, oscillation was uncontrollable at the higher end. The throttle condenser was tried, with opposite results. The set was dead from 800 kc to the high-frequency end of the spectrum.

A compromise circuit was then worked out in which both throttle and feedback was used. The fixed condenser across the plate resistor assists regeneration at the high-frequency end of the band, where the throttle is most effective in cutting it down, making control possible. The first experiment resulted in regeneration at both ends of the band and a dead spot in the center, but careful cutting and placing of tickler resulted in reasonably flat control over the whole band.

## TICKLER CAPACITY

The tickler also influenced the tuning. Its effect on the tuning coil is similar to having another capacity at ground potential inserted inside it. In effect, it became another tuning condenser, and moving it in and out of the tuning coil seemed to give a greater change in tuning than an equal amount of movement of the condenser plate. It was apparent that it would have to go at the end of the coil, and clear the winding altogether, if capacity effects were to be

(Continued on page 243)



# HOME-STUDY PRACTICAL

# RADIO COURSE

**These men used this course to get into good radio jobs**



### COMPLETE EDUCATION IN RADIO SERVICING

"The R. T. I. Course reprint is a complete education in radio servicing. It put me in my present job at a well known radio shop." James P. McIntyre, Heights, P. O., Houston, Texas.

### WELL PLEASED WITH COURSE

"I am very well pleased with the Radio Course purchased from you a few weeks ago." M. F. Anderson, 2212 S. Gilpin St., Denver, Colo.

"The R. T. I. Course is worthy of space on any radioman's shelf. He can get the value of the cost in an hour's reading." Wm. C. Mitchell, of Parchman, Miss., goes on in his letter to compare this course to a resident course costing over \$300.00.

"I am so satisfied with your Radio Technical Institute Course, that I have to congratulate you for your success in bringing it to our attention. There is no doubt this radio-service course is worth its price by several times." J. M. Ocasio, 73 E. 118th St., New York.

## AMAZING BARGAIN OFFER

Here is your chance to get practical training in radio almost free. In this single large course-manual you have the material covered by the best \$100.00 radio correspondence course. All the lessons are included in this course-manual and cover every phase of modern radio work. Men with radio training are urgently needed in defense plants, service shops, Civil Service jobs, and in the Army and Navy. Let this low priced course-book prepare you for a better job in radio or higher pay in the Armed Forces.

**IN BOOK FORM**

**\$2.50**

COMPLETE

**SPECIAL OFFER**

**READ THE DETAILS**

### PRACTICAL TRAINING

These simplified, well illustrated lessons are interesting, easy to understand and apply. The early lessons explain to you the important radio principles and methods. The later lessons in the course-manual teach you advanced servicing practice. No special previous knowledge is needed. Everything you need is included in this one large course-manual. You will find the material timely, up-to-the-minute, and of great help on the job.

### EVERYTHING IN RADIO

Every new development of radio is included in this complete course-manual. There are lessons on servicing instruments, signal tracing, transmitters, television, P.A., photo-cells, etc. Practical suggestions, service hints, repair methods. Thousands of important, time-saving radio facts are packed into this complete course-manual available today for only \$2.50, postpaid.

### LATEST DATA FOR RADIOMEN

Learn new speed-tricks of radio fault finding, case histories of common trouble, servicing short-cuts, extra profit ideas. Included are many large lessons on the use of regular test equipment, explanation of signal tracing, television to the minute, recording dope. With this information you will save enough time on a single radio job to pay the special \$2.50 price for the complete course of 22 money-making lessons. Many active servicemen used this reduced price radio training for brush-up and study of new servicing methods.

### EASY TO UNDERSTAND

The practical lessons making up this course-book are easy to follow and apply to actual radio jobs. Hundreds of radio facts that puzzled you will be quickly cleared up. You will find yourself doing radio repairs in minutes instead of hours—quickly finding the faults or making needed adjustments. Get into radio for more important war work and better pay. The Armed Forces also need radio men and give higher rank and better pay. If you are already in Radio, improve your knowledge with this low-priced radio course.

## OTHER PRACTICAL RADIO MANUALS



### HOW TO MODERNIZE RADIOS FOR PROFIT

You can learn quickly to modernize all sets. Cash in by improving audio circuits, modernizing cabinets, adding features usually found on late model sets. Practical job-sheets with schematics and photographs make the work easy. You are told how to obtain modernization work, what to charge, and how to complete the job quickly and efficiently. Large size, 8½ x 11 in. manual is priced at only.....

**\$1.00**



### SIMPLIFIED RADIO SERVICING

Revolutionary different COMPARISON technique permits you to do expert work on all radio sets. Gives practical pointers and suggestions. Covers every radio set—new and old models. In handy manual form, size 8 x 11 inches, 112 pages. Over 1,000 practical service hints. 16 large, troubleshooting blueprints.....

**\$1.50**



### MOST-OFTEN-NEEDED RADIO DIAGRAMS

The most popular radio diagrams available in low priced manuals. Large size; 8½ x 11 inches.

1942 Manual, Volume 5, 204 pages..... }  
 1941 Manual, Volume 4, 192 pages..... } **\$2.00**  
 1940 Manual, Volume 3, 208 pages..... }  
 1939 Manual, Volume 2, 192 pages..... } each NET  
 1926-38 Manual, Volume 1, 244 pages, alignment hints, parts lists..... } **\$2.50**



### PRACTICAL RADIO MATHEMATICS

Introduces and explains the use of arithmetic and elementary algebra in connection with units, color code, meter scales, Ohm's Law, alternating currents, ohm-meter testing, wattage rating, series and parallel connections, capacity, inductance, mixed circuits, vacuum tubes, curves, the decibel, etc., and has numerous examples. Net

**25c**

**See Your Radio Jobber or Send Coupon**

### 10 DAYS' EXAMINATION

All the lessons of a high priced home-study radio course have been reprinted in a single large manual. The very newest data on auto sets, signal tracers, new tubes, etc., are included. You get a complete course of training at the unheard of price of only \$2.50, nothing else to pay. And further, you risk absolutely nothing. You try the course for 10 days. If you are satisfied, the total price for the complete course is only \$2.50. If you are not pleased, you receive a complete refund without a question.

### SELF-TESTING QUESTIONS

The course-manual is supplied complete with all lessons, tube data, and supplementary material. Questions at the end of each lesson are used for self-testing and review. Order the course-manual on a 10 days' trial basis. You risk nothing. Don't pass up this remarkable offer.

### LIMITED QUANTITY ON HAND

There are only a few copies of this 5th Edition on hand. We do not know if another edition will be permitted. Rush coupon for your course. Remember that the 10 days' examination period eliminates all risks on your part. Send today—begin to use the lessons this week.

**These Lessons will tell you all about**

- Induction, Coils
- I. F. Transformers
- Alignment
- Condenser testing
- Batteries
- Filters, Rectifiers
- Reactance
- Auto antennas
- Beam power tubes
- Superhets, TRF
- A.V.C. circuits
- Ballast tubes
- Oscilloscopes
- V.T. Voltmeters
- Loud speakers
- Vibrators
- P. A. testing
- Recording
- Service hints
- And thousands of other radio topics

## "NO RISK" TRIAL ORDER COUPON

**SUPREME PUBLICATIONS, 328 S. Jefferson St., Chicago, Ill.**

Ship my copy of the complete Radio Course-Manual, including supplementary data and review questions. I must be entirely satisfied or you will refund my total remittance in full.

- I am enclosing \$2.50, full price. You pay the postage.
- Send C.O.D. I will pay the mailman \$2.50 and a few cents postage.
- Also send other Supreme Publications as listed on attached paper.

NAME: .....

ADDRESS: ..... RC

# Supreme Publications

PUBLISHERS OF RADIO BOOKS, MANUALS, AND DIAGRAMS

328 South Jefferson Street

Chicago, Illinois







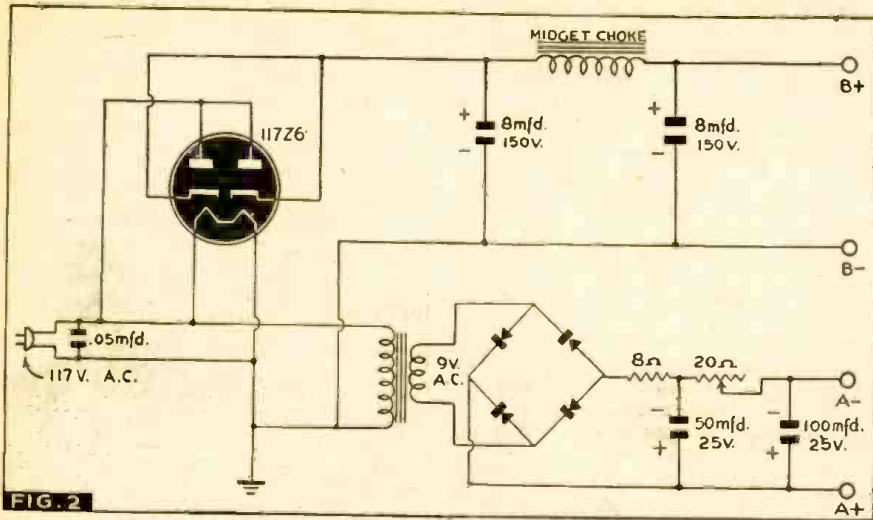

Fig. 2. The dry-plate rectifier pack, using 117Z6 for high-voltage supply.

Fig. 1. This hookup dispensed with the battery-electric switches which complicated earlier sets. By using one cathode of the 25Z5 to supply the filaments and the other side for plate power the two circuits were made independent, and it was possible to attach them directly across the batteries, so that when the set is not plugged in on the line it works off battery. When plugged in, the voltage rises high enough to overcome the battery voltages and drive a slight reverse current through them. The set then plays on the line without using any current from the batteries. A set electrified with this circuit can be used as a 3-way portable after the war, simply by restoring battery plugs.

Some sets with a 1.4-volt filament circuit can be electrified by hooking the filaments up in series and using the 1-tube power supply circuit. In many cases the grid returns will have to be changed to supply proper grid bias. We have a 6-volt drop in the filament circuit, so it becomes a simple matter to get the desired negative bias on any grid, by leading its return back to the proper point on the filament line. For instance, if the set has a 1A5 output, the tube should be placed at the positive end of the series, and the grid-leak brought to ground, giving 4.5 volts bias to the most negative

part of its filament. If the next tube is a 185G, which operates with zero grid bias, it will be necessary to disconnect its grid leak from ground, from which it is now getting 3 volts bias, and connect it to its own filament.

6 VOLT PACK

In most cases it will be better to build a 1.4 volt power pack than to change the wiring of the set. This is also true in cases where 50 and 100 MA tubes are mixed in the same receiver, and in odd-voltage sets in which tubes are operated in both parallel and series, with shunts across some of the filaments. Since both dry-plate and tube-type packs have their advantages and disadvantages, we decided to build and describe both kinds.

The pack shown in Fig. 2 uses a 117Z6G for plate power and a small copper-oxide rectifier for filament supply. A 20-ohm rheostat is connected in series with the output to bring the voltage down to an exact 6. The 8-ohm resistor was a dropping resistor originally used to prevent heavy currents when the rectifier was used to charge a small storage battery. It was left on to provide "resistor input" to the filter, and because it was needed to drop the voltage to

the required level. To use the pack on a 1.4 volt set it would be necessary to abandon the 8-ohm resistor and use a transformer and rectifier designed for 1.5-volt operation. The rheostat would still be necessary, as condenser input would raise the voltage well above the 1.4 volt desired. According to figures from the Mallory catalogue, a rectifier designed to work at 1.5 volts with a resistive load will have a voltage of 2.54 when working into a capacitive load. These figures are based on the use of an extremely large input condenser, but are useful as showing the highest voltage to be guarded against.

The transformer was one built especially for this dry-plate unit, and has a secondary output of 10 volts with no D.C. load on the rectifier. The filter circuit is composed of the two resistors and the 50 and 100 mfd. condensers. The connection of the resistors in the negative lead instead of on the positive side of the filament line was a mere matter of convenience with the parts and layout at hand. The output filter condenser was found especially important in cutting down hum, which decreased exactly in proportion to the increase in condenser capacity. The orthodox method of filtering with this kind of rectifier is to use one condenser with a capacity of several hundred microfarads ca-

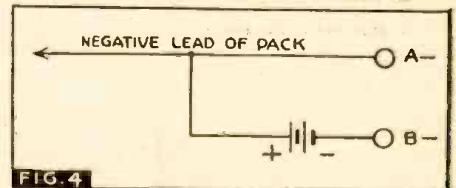

Fig. 4. Connection of "C" battery.

capacity and a very low working voltage, but it was more convenient to use radio condensers at hand.

By changing the dry-plate rectifier, this pack may be used either for 6-volt or 1.4-volt portables. The plate supply is of course the same in both cases and consists of a 117S6G, a choke from a small A.C.-D.C. midget receiver, and the two 8-mfd condensers shown.

As the effectiveness of a filter condenser drops with the voltage, it will be necessary to use approximately 4 times as much filter capacity for 1.5 as for 6 volts.

A VERSATILE PACK

An attempt to build a more universal pack was made in the one shown in Figure 3. It can be used on 6- and 1.4-volt receivers, as well as odd-voltage jobs, without changing any parts. A variable resistor in the filament circuit and a special bleeder resistor make this possible.

The pack was constructed round three 25Z5's. The filaments were all connected in series. The additional 40 volts line drop was secured by winding a 120-ohm resistor on a mica strip. This was then mounted on a piece of fibre—the mica clearing the fibre by the thickness of a couple of nuts on the mounting screws—and the whole stood up on a small bracket on the underside of the base. A line cord or any other 120-ohm, 50-watt resistor could have been used, of course.

All plates are connected in parallel, as are all cathodes. The conventional .05 condenser across the line was forgotten till the pack was in its case, and since it seemed to make no difference, was not installed.

From the cathodes of the 25Z5's, the current follows two paths: The filament supply goes through R1 and the 100-ohm bleeder to the negative terminal. R1 is an old dictograph resistor obtained from Hudson Specialty Co., New York. It is a high wattage unit and can be adjusted from zero

(Continued on page 235)

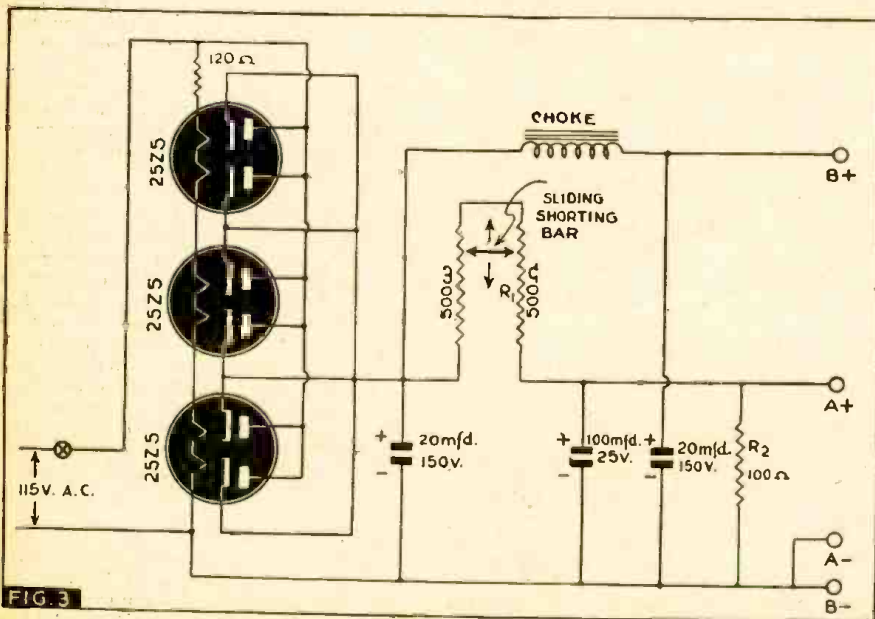

Fig. 3. The 25Z5 power pack.



# •LATEST RADIO APPARATUS.

HALLICRAFTERS ★ HALLICRAFTERS

## LET'S ALL PITCH IN!



### COMPLETE STOCKS

I still have large stocks of receivers, 2½ meter equipment, meters, tubes, transformers, resistors, condensers, panels, chassis, and radio parts of all sorts. I sell and rent code teaching equipment. Your orders and inquiries invited.

WE CAN all help win this war by selling our government the communications receivers and equipment they need quickly and in sufficient quantities.

That is the reason I pay *highest cash prices* for used communications equipment.

When this war is over you will be in the market for new equipment and by taking advantage of my offer to purchase your present equipment at highest cash prices you will be in a position to buy new and better equipment than you now own.

Write, telephone or telegraph me description of your used communications receivers, transmitters and parts of standard make; you will be paid cash immediately without bother or red tape. I am particularly interested in *Hallcrafters*.

*I also have a store at 2335 Westwood Blvd., West Los Angeles, Calif.*

**Bob Henry, W9ARA**  
**HENRY RADIO SHOP**  
BUTLER, MISSOURI

## PHOTO-ELECTRIC CELLS

Emby Products Co., Inc.  
1800 West Pico Blvd.  
Los Angeles, Calif.



THIS selenium cell is of the self-generating type with an output in excess of 450 microamperes per lumen, or 6 microamperes at an illumination of one foot-candle.

The cell is made permanently stable and can withstand temperatures up to 70 deg. C.

Spectral response extends from 240 millimicrons in the ultra-violet region, up to 720 millimicrons in the infra-red. This makes it especially suitable for determinations requiring the selective ability of human eye.

The cell has no fatigue or "drift" effect, and for most practical purposes has no measurable time lag. Response is instantaneous and light changes of frequency exceeding 10,000 cycles can be recorded.—*Radio-Craft*

HALLICRAFTERS ★ HALLICRAFTERS

"WORLD'S LARGEST DISTRIBUTOR OF COMMUNICATIONS RECEIVERS"



## SOLDERING PLIERS

Ideal Commutator Dresser Co.  
3067 Park Avenue, Sycamore, Ill.

THE No. 10 Thermo-Grip is a plier type tool intended for large size soldering. It solders lugs up to the 1050 ampere size, and can be used for sweating and unsweating threadless copper pipe and fittings, up to 2½" diameter, and for heavy stator connections.

In intermittent soldering operations it can be used for pipe and fittings up to 4-inch diameter.

Heating is more rapid and satisfactory by this method than by any other, because the pliers grip the work in two places and evenly heat the metal between them.

The unit operates on 117-volts, A.C., and



is rated at 2,500 watts in intermittent operation. Two heats are provided, the low heat being 15% less than the maximum.—*Radio-Craft*

## MIDGET RELAYS

Ward Leonard Electric Co.  
Mt. Vernon, N. Y.

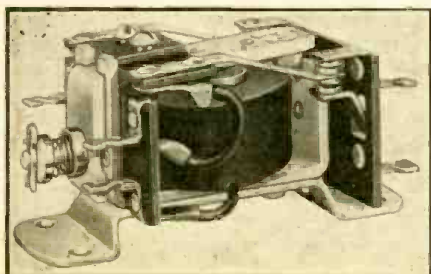

THESE Bulletin 104 relays are used most frequently in small radio transmitters, aircraft control circuits, and other applications where available space is limited. The low overall height of 1¼ inches is made possible by the metal base and the short magnetic circuit.

All current-carrying parts are supported throughout by highest quality phenolic insulation.

In the energized position the relay is resistant to vibration up to ten times gravity.—*Radio-Craft*

## SOLENOIDS

Dean W. Davis & Co., Inc.  
549 West Fulton Street, Chicago, Ill.

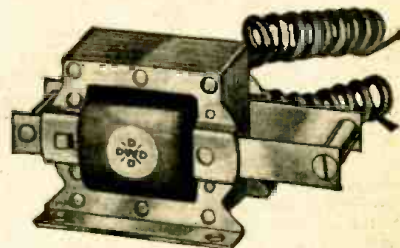

TWO new types, one a pull type and the other a "push-pull" type, are announced.

They are particularly designed for meeting industrial and electronic specifications. Maximum magnetic force for a given electrical input is affected of course by design, laminated frame and plunger, etc.

The coils may be obtained in paper section wound, or cloth-taped and treated for imperviousness to various fluids.

Installation is easy for either direct control or remote control, or for quick short thrusts. The coils are obtainable in all voltages, A.C. or D.C. in ⅞" stroke.—*Radio-Craft*

## DECADE BOXES AND WHEATSTONE BRIDGE

Industrial Instruments, Inc.  
156 Culver Avenue, Jersey City, N. J.

TYPE DR D. C. resistance decades are available in standard models with resistance ranges of .9 to 999,999 ohms total, and with guaranteed accuracy of plus/minus 1% and 0.1%, in two price classes.

All coils are of manganin wire, excepting the 100,000 ohm coils of nichrome. All coils are bifilar-wound on ceramic tubes,



oven-baked and protectively-coated. Switches have self-cleaning multi-blade phosphor-bronze spring wipers.

The instruments are housed in rubbed walnut cases.

The Wheatstone Bridge Type RN-1 contains four resistance dials with nine positions each, covering 9 x 1, 9 x 10, 9 x 100, and 9 x 1,000 ohms, with decade multiplying dials. The ratio resistances have a guaranteed accuracy of plus/minus .05%, while the resistance coils in the decades of the bridge are guaranteed to plus/minus .1% tolerance.

Specifications for switches and cabinet are the same as for the decade boxes already described. The galvanometer is of the well-proven moving-coil type with sensitivity of 1 microampere per division.

Three standard flashlight cells comprise the 4½ volt battery in the cabinet, readily accessible without removing the panel.

External battery connections are provided also.—Radio-Craft

### MOLDED PLYWOOD FOR RADIO MASTS

Bakelite Corp.,  
New York, N. Y.

**L**IGHT, strong 15-foot tubes of molded plywood are being assembled into radio masts by the U. S. Army—thus saving aluminum previously required. This is just one of the many applications for which plywood (bonded and impregnated with BAKELITE synthetic resins) is being used in war service today. Even more spectacular is the use of this material for the manufacture of plywood airplanes and gliders. For the giant cargo planes, too, plywood and laminated wood bonded with synthetic resins, figure in many vital parts. Even now big two-motor bomber-trainers are being made of plywood in this country and in Canada.

For non-war purposes the field of plywoods bonded and impregnated with synthetic resins is expanding, at an encouraging rate.—Radio-Craft

## NEW POLICE RADIO EQUIPMENT

**N**EW mobile FM police radio equipment developed and manufactured for the radio reserve pool, by the General Electric Company, incorporates many new features, some of them suggested by police users in many parts of the country.

35% and the effective communication range improved.

A convenient work-bench support, which also serves as a part of the cover-latch mechanism of the transmitter and receiving units, provides a rigid support when the



Iron-core, or inductive tuning (the closely controlled movement of an iron core in and out of a small form-wound coil) is used. This permits easier and more accurate tuning, and reduces the effects of car vibration on tuning adjustments.

Receiver battery drain has been reduced

chassis is inverted for inspection or repair.

A series of test jacks permits direct simultaneous readings of several functions at one time. All tube sockets and tuning controls are clearly stenciled on top of the chassis.



Send for this FREE 52-page Book. It shows that "crack" operators rely on something besides practice to develop their high speeds and proficiency; it explains the "knack" of sound-sense and sound-consciousness—the secret of speedy sending and receiving. Once you acquire these mental processes, reading code becomes almost second nature to you; just as the swing rhythm of a dance band becomes automatic to musician and dancer.

Champions endorse the Candler System. Used in training commercial operators, Amateurs, and Radiotelegraph Specialists in Signal Corps, Navy, Marine Corps, Coast Guard, Naval Reserve, Airlines. Wherever the fastest and most efficient operators are found, there you will find Candler trained men.

If you want s-p-e-e-d, if you have any difficulties in operating technique, if 40-50 and more w.p.m. seem fantastic speeds to you—send for this revealing book now. It's yours without cost or obligation. Simply send your name and address.

### CANDLER SYSTEM CO.

P.O. Box 928, Dept. 3-A  
Denver, Colorado, U. S. A.  
(Room 55), 124, Kingsway, London, W.C.2.

### RADIO-TELEVISION INSTITUTE

Not just another radio school, but a TRAINING ORGANIZATION well equipped with LATEST and MOST EXPENSIVE APPARATUS and staffed by PRACTICAL RADIO ENGINEERS who understand the various branches of RADIO, TELEVISION and the manifold uses of ELECTRONICS.

Our students quickly find profitable positions.

Resident course only. Inquiries invited.

### Radio-Television Institute

480 Lexington Ave.  
New York City

Licensed by the State of New York

### RADIO TECHNOLOGY

RCA Institute offers an intensive two-year course of high standard embracing all phases of Radio and Television. Practical training with modern equipment. Also shorter specialized courses in Commercial Radio Operating, Radio and Television Servicing, and Aviation Communications. For Free Catalog write Dept. RC-43.

**RCA INSTITUTES, Inc.**  
A Radio Corporation of America Service  
75 VARICK STREET NEW YORK

### PRE-INDUCTION RADIO COURSES

FOR CIVILIANS AND THOSE ENTERING MILITARY SERVICE  
New Classes Now Starting  
• RADIO OPERATING • CODE  
• RADIO SERVICING

New York Y.M.C.A. Schools  
4 W. 64th Street New York City

### MELVILLE

AERONAUTICAL RADIO SCHOOL, Inc.  
45 West 45th Street New York City

Training Men & Women for Radio in the Service of  
AIRLINES-ARMY-NAVY-MERCHANT MARINE  
COAST GUARD-INDUSTRY



# FOR VICTORY TODAY AND SOUND BUSINESS TOMORROW



## *Get This Flag Flying Now!*

This War Savings Flag which flies today over companies, large and small, all across the land means *business*. It means, first, that 10% of the company's gross pay roll is being invested in War Bonds by the workers voluntarily.

It also means that the employees of all these companies are doing their part for Victory . . . by helping to buy the guns, tanks, and planes that America and her allies *must* have to win.

It means that billions of dollars are being diverted from "bidding" for the constantly shrinking stock of goods available, thus putting a brake on inflation. And it means that billions of dollars will be held in readiness for post-war readjustment.

Think what 10% of the national income, saved in War Bonds now, month after month, can buy when the war ends!

For Victory today . . . and prosperity *tomorrow*, keep the War Bond Pay-roll Savings Plan rolling in *your* firm! Get that flag flying now! Your State War Savings Staff Administrator will gladly explain how you may do so.

If your firm has not already installed the Pay-roll Savings Plan, *now is the time to do so*. For full details, plus samples of result-getting literature and promotional helps, write or wire: War Savings Staff, Section F, Treasury Department, 709 Twelfth Street NW., Washington, D. C.



Save With

## War Savings Bonds

This Space Is a Contribution to America's All-Out War Program by

### RADIO—CRAFT



# HOW SIGNALS ARE SENT

By C. W. PALMER

**T**HE beginner in radio while he is busy building a small receiver probably is also interested in how radio signals are sent and received. To begin with, if you have a copy of the October issue of *Radio-Craft*, refer to the article in which atoms and electrons were explained. We will remember that each atom was made of a certain number of electrons and protons, arranged in "shells" or orbits very similar to the way in which the stars rotate around the sun. The electrons that move in this way are known as *planetary* electrons to differentiate them from the electrons in the nucleus. It requires the application of a force to move one of these electrons away from the atom, which then leaves the atom with an unbalanced positive charge. Each electron possesses a certain amount of attraction to the atom, depending on the distance separating it from the nucleus.

## ENERGY

It is a well-known law of physics that energy can neither be created nor destroyed. It can, however, be transferred from one form to another. There are two kinds of energy—kinetic energy, which is *energy in motion*, as the force of a vehicle in motion—and potential energy, or the *energy at rest*, such as a large rock suspended at a height which becomes very powerful if released. See Figs. 1 and 2.

Now to return to the atom. If an electron is knocked from one orbit to another, some energy is either absorbed or emitted. If the electron is knocked from an outer to an inner orbit, for example, the difference in the attraction of the two positions must be given up. This energy is radiated in the form of electromagnetic radiations and for

each electron moved, a certain definite amount of energy known as a "quantum" is radiated into space at the uniform speed of 186,000 miles per second.

All this may seem rather far removed from radio transmission, but we will soon see how the two are connected. According to the theory of radiant energy, it is the scattering or radiating of these tiny units of energy through space that makes up the radio waves or rays. We are not certain

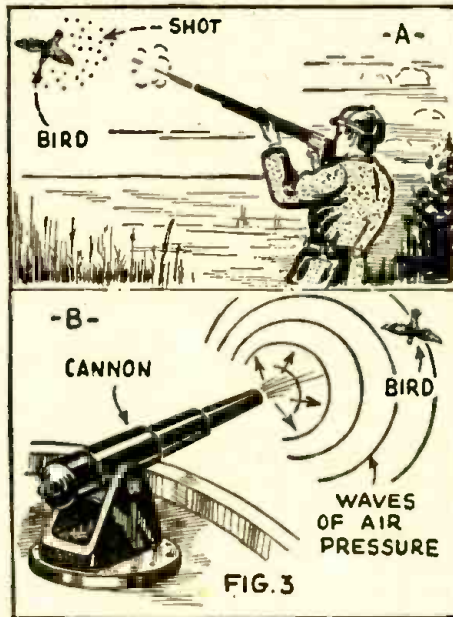

whether the energy is transmitted by a sort of wave motion, as in the case of sound waves, which vibrate the air, or if groups of quanta move through space like bullets shot from a gun. To illustrate this, Fig. 3 shows two ways in which a bird may be killed, first by being struck by lead bullets and second by the concussion from large cannon being fired.

It seems probable at this time that the facts may be best explained by the wave theory, although if we consider the transmission of energy, the quantum theory is necessary for a satisfactory explanation of the conditions. Energy can be transmitted from one place to another by one of two means; either by wave disturbances as illustrated by the cannon or by the motion of particles of matter from some source. According to the wave theory, an electromagnetic disturbance travels by a wave motion and as it is impossible for most people to think of waves without a medium (as the water for ocean waves, the air for sound waves, etc.) a hypothetical "ether" has been used as the medium to carry the magnetic wave motion.

## ANOTHER EXPLANATION

If the above description of the radio wave is difficult to visualize, perhaps we can give another illustration that will make it easier. If we refer again to the first article of this series and read over the explanation of induction, we will find the explanation. In just the same way as the current in one

coil can start a similar current in the second coil, the current at the transmitter sets up currents in the receiver. If the two coils of the induction experiment are small, the magnetic field around the coils is small. On the other hand, if the coils are made larger, the field also increases in size.

To transport energy over a great distance, it would seem that enormous coils would be necessary. Such a conclusion is correct, but instead of having a very large coil generating the field, as pictured in Fig. 4, a long wire suspended high in the air is used. This wire, called an *aerial* or *antenna*, generates a large field that extends many miles and may induce a current in another wire, similar in construction to the first. Fig. 5 shows how this is accomplished.

## FREQUENCY OF RADIATION

We will remember that the frequency of an alternating current flowing in a wire is the number of times that it changes its direction of flow, or in other words, the number of times the electrons change their direction back and forth. Frequency in radio transmission is similar to this, except that the energy is transmitted without the use of wires and instead of moving in a definite direction, it is carried in all directions away from the aerial of the transmitter, returning through the ground as it were.

If the wave reversals are between 550,000 and 1,500,000 times a second, we say that the waves are sent at a frequency of 550,000 to 1,500,000 cycles or more commonly 550 to 1500 kilocycles, which is the band of frequencies used for the regular broadcasting (Continued on page 248)

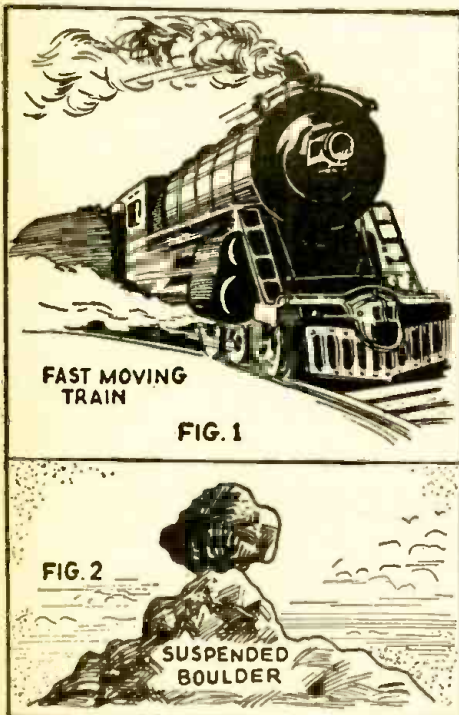

Fig. 1—Example of "kinetic" energy; Fig. 2—"Potential" energy.

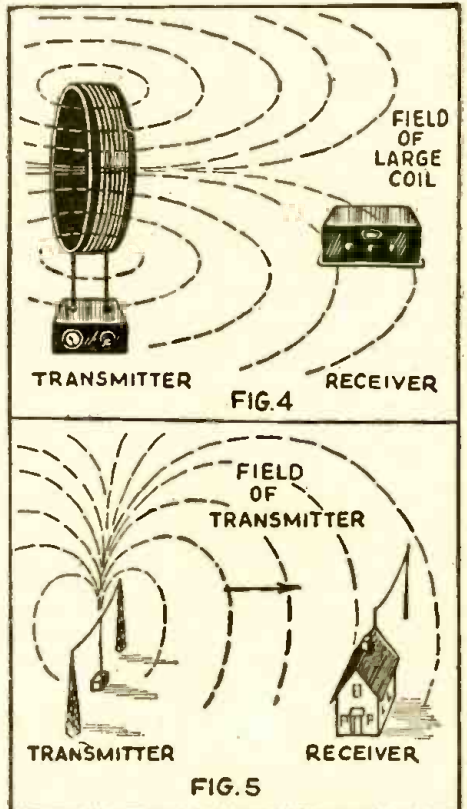
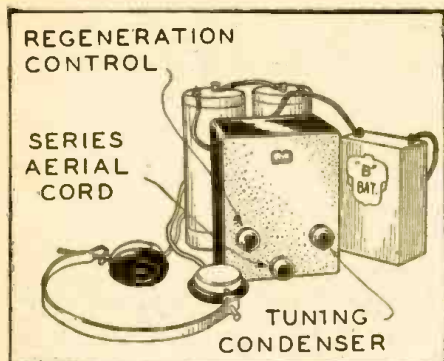

Fig. 4—Transmission by induction; Fig. 5—Ether wave transmission.



# ONE-TUBE ALL-WAVE BATTERY SET

By W. GREEN



**T**HE use of the type 19 tube, a twin triode, makes possible the battery operated version of this remarkable set.

Full 2-tube performance is obtained by using both sections of the type 19 as separate circuits; one section as the detector tube and other as a stage of audio.

As you may see from the illustrations, the layout is as simple as can be. Two sockets, one for the tube, and one for the coil and the tuning condenser are the only major parts on the chassis. The regeneration control and the antenna coupling condenser are mounted on the panel. In the space of a few hours the set can be completely assembled, wired and set up for operation. Its smooth performance and easy handling are a pleasure even to the experienced ham. You will find the set brings in the nearby as well as the distant stations

with unusual ease. All components are well insulated, and the parts are laid out

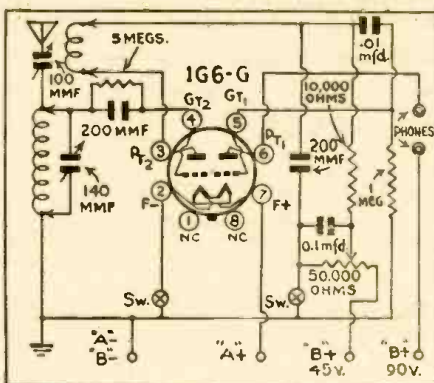

The circuit of the 2-in-1 all-wave set.

so that all wiring (especially high frequency connections) are very short. Potentiometer type of regeneration control, though a little more costly, makes the operation of the set positive. The appearance of "dead spots" is eliminated by the use of a small variable coupling condenser in series with the antenna. The switch is attached to and is part of the regeneration control. A double-pole switch is used. One turns off the filament current, the other disconnects the "B" battery, thus removing all battery drain when the set is not used.

### COIL WINDING DATA

The coils are wound on small 4-prong forms, 1 3/8 in. diameter, and 1 3/8 in. long. Coils A, B, and C are wound with No. 25 D.S.C. wire, and coil D with No. 30 D.S.C. wire. The bottom winding is put on first and connected to the two heavy prongs, and then the top winding to the two thin prongs. Turns: A—2 3/4-7 3/4; B—6 3/4-7 3/4; C—17 3/4-8 3/4; D—38 3/4-11 3/4.

Accessories needed are a type 19 tube, a pair of sensitive phones, and an antenna. The antenna may be an ordinary single

wire antenna, high and clear of nearby buildings, trees, etc., about 35 to 75 feet long. It should be well insulated so that there will be no possibility of the antenna wire or lead-in grounding at any point. Batteries needed are but two dry cells and two 45 volt "B" batteries.

### List of Parts

- One 6-prong socket, 19
- One 4-prong socket
- One 50,000 ohm potentiometer, with D.P.S.T. switch
- One Harrison dial drive
- One Harrison dial scale
- One variable condenser, 140 mmf.
- Two 200 mmf. condensers
- One 5 megohm resistor
- One .01 mf. condenser
- One 10,000 ohm resistor
- One .1 mf. condenser
- One 1 megohm resistor
- Three knobs
- One 100 mmf. antenna coupling condenser
- One speaker jack
- One extruded washer
- Two knurled nuts

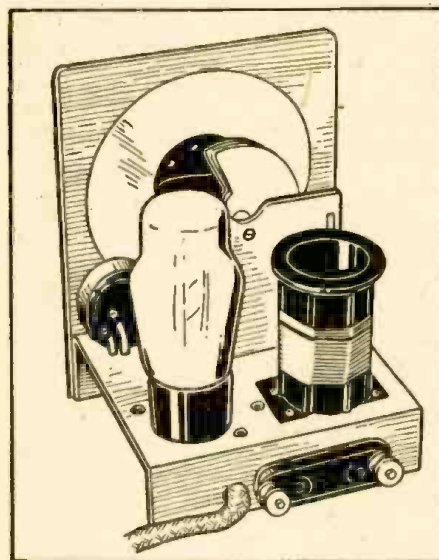

Underside view of one-tube all-wave battery set.

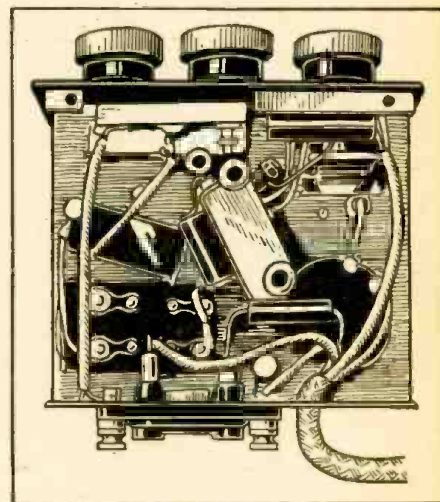

Rear view of the one-tube all-wave battery set.

## USE THE TUBE MANUAL

**I**T cannot be too often stressed, not only for the beginner, but for the intermediate experimenter and constructor as well, how essential it is to have a receiving tube manual on hand at all times. It can be obtained for 35 cents at your radio supply store, or from RCA, Harrison, N. J., or Raytheon, Waltham, Mass.

It is folly to be without one. We are all familiar with the case of the luckless chap who starts out following a diagram, matching lead for lead, without regard to the difference of location of proper terminals on diagram and on the socket itself. He blithely turns on the juice, and zip! There goes another tube (or sometimes all the tubes).

All this could have been avoided of course if he had taken the trouble to look up the tubes in the manual. He would have found the tube element connections plainly marked, and he would have noted particularly that the view of the socket shown is the *bottom view*.

The reason the bottom view is shown is because most tubes are wired on the chassis, and the socket when wired up is looked at from its under side.

However, in the case of a bread-board layout, with the tube socket mounted on spacers on top of the board, the numbering order of the soldering lugs on the socket is just the *reverse* of that shown in the manual.

Therefore the first thing the smart be-

ginner does is to study the socket connections thoroughly, get familiar with the number of connections and their order. Then when he wires up he checks back and forth, and experiences no grief.

Another great use of the tube manual lies in the vast amount of solid usable technical information it contains.

It discusses automatic volume control, rectification, power tubes and circuits, detection, oscillation, frequency conversion in superheterodynes, etc.

Tubes are listed and classified as to similar characteristics, filament voltages, power output, etc., so a proper choice of tubes can be made when making experi-

(Continued on page 256)



# MICROPHONES EXPLAINED FOR THE BEGINNER

THE 5 most common types of microphones used for P.A. systems and broadcast studio work are:— the carbon, condenser, ribbon or velocity, dynamic or moving coil, and crystal. Each one has its advantages and disadvantages and so we shall consider each type in the order named.

## CARBON MICROPHONES

The carbon microphone depends for its operation on the varying resistance of a carbon element when subjected to varying pressure.

The usual arrangement of this type unit, for best fidelity, consists of 2 carbon buttons one on either side of the diaphragm. This metal diaphragm—in a properly-built carbon microphone—is stretched and air damped so that the effects of self-resonance vibrations are negligible, giving a reasonably uniform output at all ordinary audio frequencies.

This unit has the disadvantage of a background noise called "carbon hiss,"

which is caused by the passage of current through the granules. It has a high maintenance factor and must be handled with care. On the other hand it has the advantage of a very good power output level of -30 db., together with low output impedance, making it possible to have the microphone some distance from the amplifier. See Fig. 1, A and B.

## CONDENSER MICROPHONES

The diaphragm of the condenser microphone constitutes one of the plates of a variable air condenser, while the back plate, which is separated from the diaphragm by a film of air about 1/1,000-in. thick, acts as the other plate. See Fig. 1C. Capacity variations of this condenser, in series with coupling condenser C, develop minute A.F. voltages which are then amplified by a 1- or 2-stage "head" amplifier. In actual practice, the condenser and head amplifier (or "preamplifier") are all housed in the same case and the whole unit is called a condenser microphone.

After the signal leaves the pre-amplifier, it has about the same output level as that of a double-carbon type. The same principle of stretching and damping the diaphragm is applied to the condenser type as is used in the carbon microphone, thus giving about the same fidelity of output. However, there is a noticeable absence of background hiss, and the ruggedness of the unit is a decided advantage.

## REBON OR VELOCITY MICROPHONES

The ribbon-type microphone is so named because the armature is a light corrugated ribbon of aluminum alloy. See Fig 1D. This type is also called a velocity microphone because the voltage induced in the ribbon is proportional to the instantaneous velocity of the air in the sound wave. The aluminum ribbon is suspended in the field of a permanent magnet and when sound waves strike the ribbon it vibrates, cutting the magnetic lines of force.

Whenever a moving conductor cuts lines of magnetic force, an electromotive force is induced in the conductor. Thus in this case we will have set up in the ribbon a small e.m.f. whenever it vibrates. Since the mass of the ribbon is extremely low, an excellent frequency response is obtained, extending well beyond the upper limits of the regular stretched-diaphragm-type microphone. This extended range of audio response is not very important as far as speech is concerned but does add brilliance to the reproduction of sound from musical instruments.

The output of this unit is approximately the same as that of a condenser-type microphone, so it also requires a 2-stage amplifier to bring the output level up to about -30 db.

The velocity microphone is a low-impedance device, but it always has a coupling transformer mounted right in the microphone case. By matching the line impedance to that of this coupling transformer, the amplifier may be located some distance from the unit itself, provided the connecting cable is properly shielded.

This type microphone is of a rugged nature and also possesses a very marked directional effect, the greatest response being obtained at right-angles to the plane of the ribbon; an "acoustical labyrinth" is sometimes provided to enhance the directional characteristic by absorbing 1/2 the back-wave. The construction of the microphone is of such a nature that its operation is very quiet and free from noise or hiss.

## DYNAMIC MICROPHONES

The operation of the moving coil or dynamic microphone, like the dynamic loud-speaker, is fundamentally that of a conductor moving in a magnetic field, thus generating an e.m.f. in the conductor. See Fig 1E. The diaphragm is made of thin duralumin which—in a high-grade unit—is pressed into a dome shape for stiffening to secure a piston action over the audio frequency range; improved frequency response is achieved by providing an "air passage" to afford outlet for the backwave.

The moving coil is made from thin aluminum ribbon cemented to the diaphragm, and moves in the air gap between the pole pieces. The permanent magnet is composed of cobalt alloy steel, which will

(Continued on page 238)

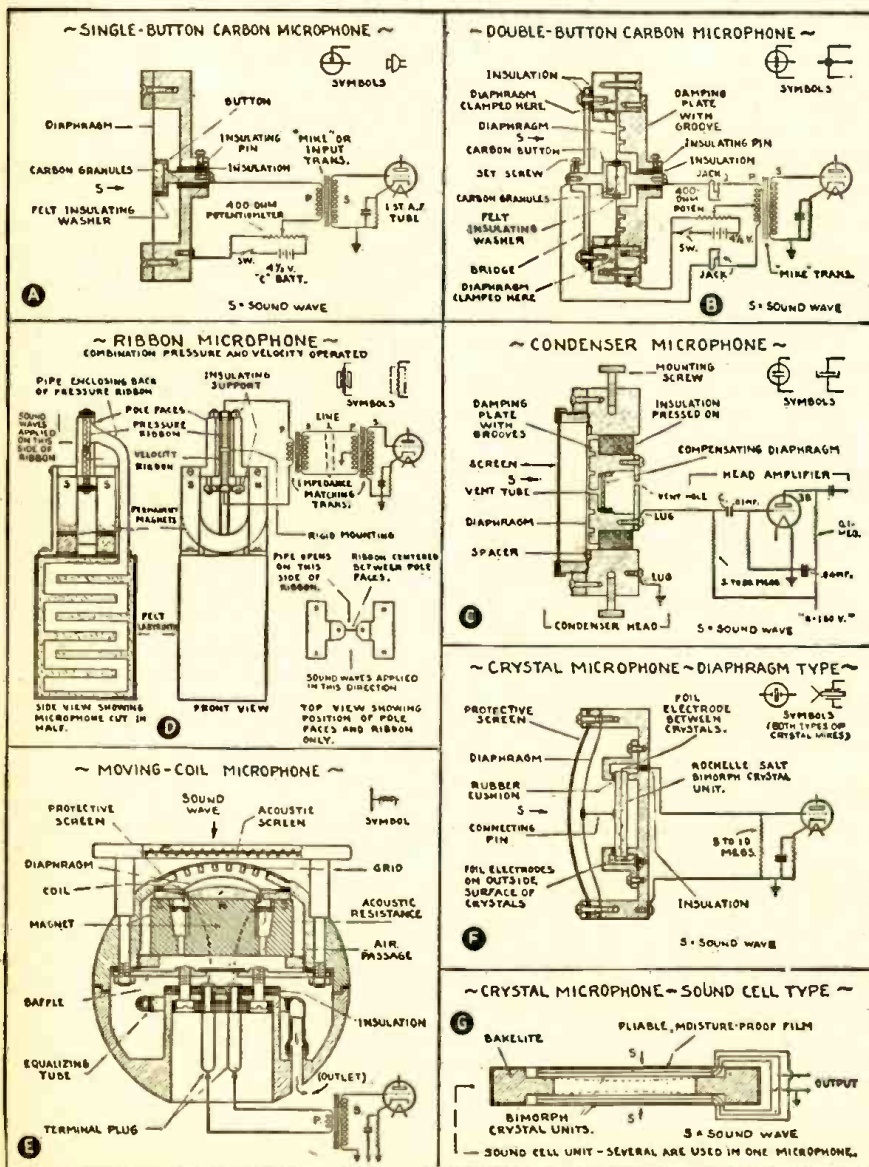



# SERVICING A.C.-D.C. MIDGETS FOR BEGINNERS

**A**LTHOUGH this article deals primarily with the servicing of the A.C.-D.C. type T.R.F. receivers, for which circuit diagrams are not obtainable, the procedures described apply equally well to these T.R.F. receivers when circuit diagrams are at hand, and will also prove of value in servicing A.C.-D.C. superheterodyne receivers.

The signal circuits of a midget T.R.F. radio set are extremely simple. Generally there is one stage of radio-frequency amplification using a 6.3-volt super-control

tubes were often used by some manufacturer to keep costs down while making the customer think he is getting a larger receiver.

### TYPICAL A.C.-D.C. CIRCUIT

In Fig. 1 is shown the typical signal circuit arrangement of an A.C.-D.C. T.R.F. receiver. There are several peculiarities which should be noted; these are: (1) the chassis may not be an electrical part of the circuit, in which case the ground symbols simply indicate that the parts so marked are connected together; (2) the screen-grid of

circuit and the line cord plug is inserted in such a way that the chassis connects to the hot (ungrounded) side of the power line, you may get a shock when you touch the chassis if some part of your body is grounded. If you get a shock, reverse the line plug if the source is A.C.; this will connect the chassis to the grounded side of the power line. In the case of D.C. power you cannot reverse the plug, for that would make polarity incorrect; you will simply have to avoid standing on a concrete floor (a good ground), and avoid touching any grounded object while working on the set with power on. With either A.C. or D.C. power, never make a direct connection from the chassis to an external ground, for this may short-circuit the power line and blow the line fuse.

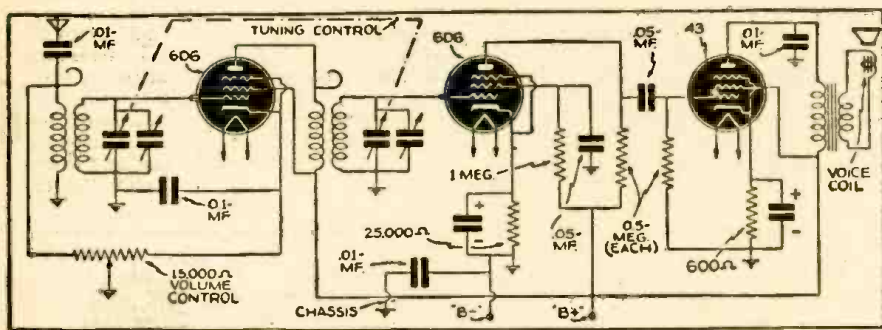

Typical circuit of a midget A.C.-D.C. receiver.

pentode tube such as the 78, 6D6 or 6K7. The former two types have the same base and are interchangeable, while the latter uses an octal base.

The R.F. amplifier feeds into the detector, which uses a pentode tube having a sharp plate-current cut-off characteristic. Interchangeable, type 6C6 or 77 tubes, or the octal-base 6J7 tube will generally be found in the detector stage.

The audio output of the detector is fed by means of resistance-capacity coupling into the power output tube, which is generally a type 43 pentode. This tube in turn feeds the loudspeaker; although a dynamic loudspeaker is more often used, you will occasionally encounter a magnetic speaker.

In some sets one or more dummy tubes will be found, with only the filaments connected into the circuit. As long as the fila-

ment circuit is not open, the condition of a dummy tube is immaterial; in fact, defective voltage in the secondary in the usual way. If the chassis is an electrical part of the

ment circuit is not open, the condition of a dummy tube is immaterial; in fact, defective voltage in the secondary in the usual way. If the chassis is an electrical part of the

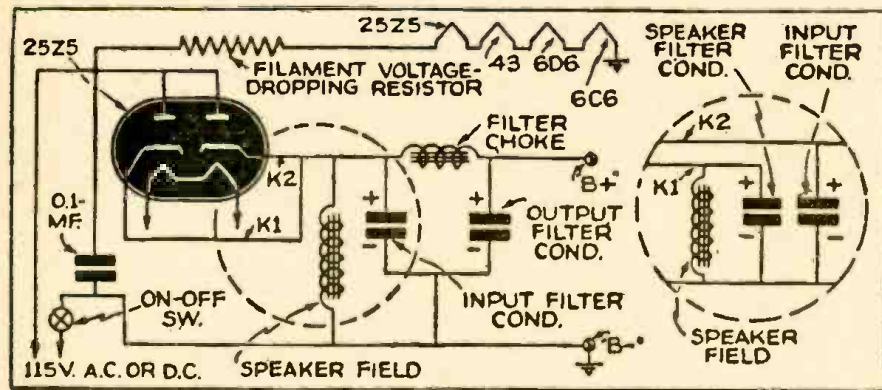

Typical power-supply circuits of A.C.-D.C. sets.

### TYPICAL A.C.-D.C. POWER SUPPLY

Figure 2 shows a typical power supply circuit used for both T.R.F. and superheterodyne A.C.-D.C. sets. A 25Z5 tube is connected as a single half-wave rectifier, but where the loudspeaker field coil is energized independently of the receiver circuit, there will be a separate connection to each cathode and an extra filter condenser connected directly across the loudspeaker field, as indicated in the dotted circle at the right in Fig. 2.

The tube filaments are wired in series, with each filament requiring 0.3-ampere. The filaments of the type 25Z5 and 43 tubes require 25 volts each, while the 6D6 and 6C6 tubes each require 6.3 volts. This makes a total of approximately 63 volts, and means that the filament voltage-dropping resistor must drop 115-63, or approximately 52 volts. Since 0.3-ampere flows through this resistor, it will have a value of  $52 \div 0.3$ , or approximately 175 ohms.

If pilot lamps are used, they are usually placed in series with the voltage-limiting resistor. Each lamp is operated at about 4.25 volts, and hence the required voltage drop across the limiting resistor is reduced by this amount. Two pilot lamps connected as in Fig. 3A reduce this required voltage drop by 8.5 volts. (Although the lamps are rated at 6.3 volts, they are operated at 4.25 volts to prevent burn-out on surges.)

Pilot lamps are always shunted by resistors, for these lamps do not draw as much current as the tube filaments. The shunt resistance will be equal to the shunt current (the difference between the 0.3-ampere filament current and the pilot lamp current) divided into the voltage across the lamp or lamps.

### PILOT LAMP COLOR CODE

On A.C.-D.C. sets, only 2 types of pilot lamps are ordinarily used; these can be identified by the color of the glass bead through which the filament-supporting wires pass. A mazda No. 40 lamp with a miniature screw base draws 0.15-ampere and has a brown-colored bead. A mazda No. 46 lamp with a miniature screw base draws 0.25-ampere and has a blue bead, while a mazda No. 44 lamp with a bayonet base also draws 0.25-ampere and has a blue bead. A third type of lamp, having a white bead and drawing 0.20-ampere, is infrequently encountered. Replace burned-out lamps with new lamps having the same bead color and voltage rating (6.3 volts).

You will occasionally find 2 pilot lamps

ment circuit is not open, the condition of a dummy tube is immaterial; in fact, defective

voltage in the secondary in the usual way. If the chassis is an electrical part of the



connected in series directly across the 110-volt line, with no shunt resistor across them. These will be 110-volt cheap lamps similar to those used on Christmas trees. They are connected in series to operate at half-voltage, thereby having longer life while still giving sufficient light to illuminate the tuning dial.

**TYPES OF HEATER RESISTORS**

Various types of filament voltage-dropping resistors are used in A.C.-D.C. sets. Many of the earlier models use ordinary wire-wound resistors mounted under the receiver chassis. The chief disadvantage of these is that the heat which they radiate causes deterioration of nearby receiver com-

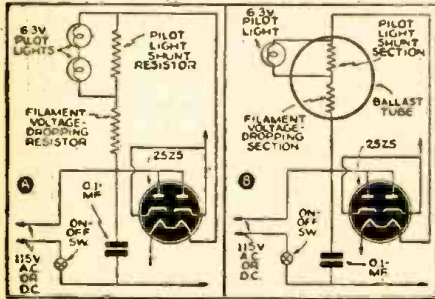

A and B are different pilot light hookups.

ponents, chiefly the electrolytic condensers. Line cord resistors, having the resistance wire embedded in asbestos and placed in the line cord along with the usual 2 copper wires, are now widely used because they keep the dissipated heat entirely out of the chassis. Line cords are easily identified by the fact that they have 3 leads instead of 2; the resistance wire is connected to one of the line wires, the connection being made directly to one of the prongs on the line cord plug. The line wire which connects to this same prong may be identified with an ohmmeter, and always goes to the rectifier plates. The other line wire will go to the ON-OFF switch which is mounted on the volume control of the receiver.

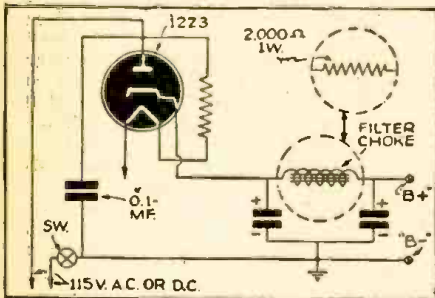

The rectifier and filter circuit.

When a receiver which uses a line cord resistor is in operation, the line cord becomes quite hot, but this is natural and is no cause for worry. Never attempt to shorten the line cord when it has a built-in resistance, for this would reduce the resistance value and affect the operation of the receiver.

Ballast tubes are even more satisfactory than line cord resistors for filament voltage-dropping purposes. These tubes came in either glass or metal envelopes, the metal envelope being the more popular before the war. The resistance element is mounted inside the envelope and connected to prongs on the tube base. Oftentimes taps are provided, with connections to tube prongs, to eliminate need for separate pilot lamp shunt resistors; an example of a ballast tube having one tap for this purpose is shown in Fig. 3B.

When a ballast tube burns out, always replace it with another having exactly the same number. This is necessary because the tubes are made with many different ohmic values and with many different arrangements of prong connections. Ballast tubes become very hot while in use, but as the heat is above the chassis, critical parts in the receiver are not damaged.

Service men are sometimes asked to replace line cord resistors with ballast tubes; space limitations make it difficult to attempt this, but it can be done sometimes. Incidentally, an ohmmeter provides the quickest way of identifying the various prongs on a ballast tube.

**RECTIFIER CIRCUIT VARIATIONS**

A single 12Z3 rectifier tube or even a type 37 triode with grid and plate connected together may be found in a circuit arrangement like that in Fig. 4. Since supplying field excitation to a dynamic speaker would place too heavy a drain on the rectifier, you may expect to find a magnetic loudspeaker in a receiver having this power pack circuit. The 0.1-mf. condenser connected across the power line tends to prevent interference from entering the receiver by way of the power line. Oftentimes a 2,000-ohm, 1-watt resistor is used in place of the more efficient but bulkier and more costly filter choke, as indicated inside the dotted circle in Fig. 4.

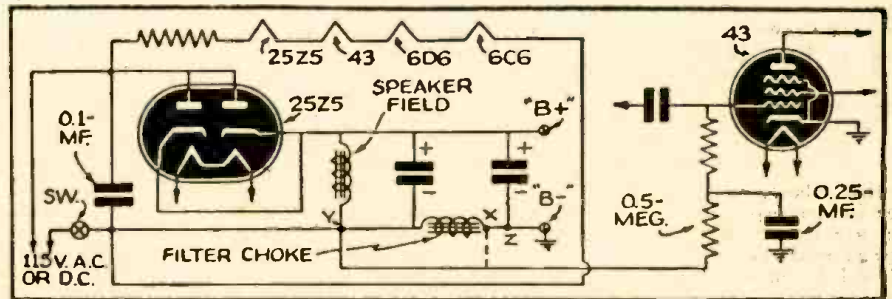

Another power-supply circuit with the filter choke in the negative plate-supply lead.

Sometimes you will find a circuit which uses two 12Z3 tubes connected in place of a single 25Z5; the circuit will be the same as that in Fig. 2 except that the 2 diode sections of the rectifier tube will be in separate envelopes. The filaments of the two 12Z3 tubes will be in series and will together be electrically equivalent to the filament of a single 25Z5 tube. This gave the set an extra tube and was therefore an advantage from a sales standpoint.

The 2 tubes supply sufficient power for loudspeaker field coil excitation, and hence a dynamic loudspeaker will usually be found. A single 12Z3 tube cannot, however, supply enough current for both the loudspeaker field coil and the receiver circuits and last a normal length of time.

Another power pack circuit using a 25Z5 rectifier tube is shown in Fig. 5. Here the filter choke is placed in the negative plate supply lead, and the voltage drop across the choke is used as C bias for the control grid of the power tube. When the voltage drop across this choke is not correct for biasing purposes, a resistor is inserted between points x and z in Fig. 5, and the control-grid return lead of the power tube is run to point x, as indicated by the dotted line, instead of point y. The ohms value of the inserted resistor is so chosen that the voltage drop across the resistor equals the correct bias voltage for the tube. Notice that the cathode of the power tube is grounded, eliminating the need for a cathode bypass condenser and resistor. A decoupling resistor and condenser are required in the control-grid circuit of this tube, however.

A rather unique method sometimes used to secure a positive screen-grid voltage for the detector tube is shown in Fig. 6. Observe that here the detector screen-grid is connected directly to the cathode of the power tube, which is sufficiently positive with respect to the detector tube cathode for this purpose.

**FILTER CONDENSERS**

*Filter Condenser Connections.* When the filter choke is in the positive side of the power pack circuit, all electrolytic condensers will have a common negative lead. When the filter choke is in the negative side of the circuit, however, the negative side of the input filter condenser does not connect to ground (chassis) and consequently requires a separate lead. In this case the 2 filter condensers may have a common positive lead, as is the case in Fig. 5.

Failure of filter condensers is quite a common occurrence in A.C.-D.C. receivers. Oftentimes there will be no markings whatsoever on the old condenser block to serve as a guide in ordering a new unit; in a case like this, the following method of reasoning will allow you to order a satisfactory replacement.

Make a sketch of the old condenser block, showing all leads which come out from it. Now trace each condenser lead and determine where it goes in the circuit. By this

time you will be able to recognize the type of power pack circuit used. Label each lead on your sketch according to the point to which it connects, and indicate its polarity. Once you recognize the type of circuit used, you will have no difficulty in determining the polarity of any point with respect to the "B-" lead and in drawing the internal connections for the condenser sections. Condenser block sketches for the power pack circuits given previously in this article are shown in Fig. 7.

Here are a few tips towards identifying the various leads. If the filter choke is in the positive side of the power pack circuit, as evidenced by a direct connection from one of the choke terminals to the cathode or cathodes of the rectifier tube, then all of the filter condensers in the block will have a common negative lead. You can identify this common lead by the fact that it connects to the receiver side of the ON-OFF power switch either through the chassis or through a common lead. Once this is done, you can draw in the internal connections of the condenser block just as has been done in Fig. 7.

If the choke is in the negative side of the power pack circuit, as evidenced by the rectifier tube cathode tracing directly to the screen grid of the power tube without encountering any current-limiting or choking devices, you can locate the negative lead for the input filter condenser by the fact that it will be the only filter condenser lead connected to the switch side of the filter choke.

Where the loudspeaker field coil gets its  
(Continued on following page)



# BEGINNERS

current from a separate section of the 25Z5 rectifier tube, there will be a condenser across the loudspeaker field coil with its negative lead also connected to the switch.

In most cases a single common negative lead is used for both condensers. The positive leads for these condensers are easily identified; the positive lead of the loudspeaker filter condenser will go to the same 25Z5 cathode to which the speaker field is also connected, while the positive lead of the

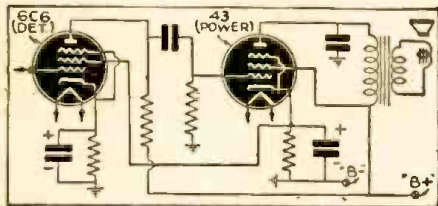

The detector screen-grid obtains its bias from the cathode of the power tube.

input filter condenser will go to the other cathode of the rectifier tube.

Having located the leads and determined the functions of the various sections of the electrolytic filter condenser block, you are ready to place on your sketch the approximate capacity values for each section. Use the following general rules as your guide.

**Input Filter Condenser**—any value between 10 mf and 20 mf, rated at 200 volts D.C. working voltage; **Output Filter Condenser**—any value between 8 mf. and 16 mf. rated at 200 volts D.C. working voltage; **Loudspeaker Field Coil Filter Condenser**—between 4 mf. and 8 mf., rated at 200 volts D.C. working voltage; **Cathode Bypass Condensers**—5 mf., rated at 25 or 35 volts D.C. working voltage.

While condensers smaller than the minimum values given should not be used, the maximum values may be exceeded without impairing the operating qualities of the receiver. The voltage ratings can likewise be higher than the minimum values given.

Your electrolytic condenser block sketch

fully considered before attempting service work, in order to make sure that the owner's complaint is justified. These little receivers are designed primarily for reception of powerful local stations which are spaced well apart in the broadcast band. The receivers have little selectivity, so that local stations which are separated by less than 100 kc. may be expected to interfere with each other. The receivers likewise have poor sensitivity, and the reception of distant or even semi-distant stations will therefore be unreliable.

Where the complaint of the owner simply involves one of these factors, no service problem exists.

Likewise, good fidelity and freedom from blasting at full volume should not be expected from these receivers, particularly if they employ a magnetic-type loudspeaker. *The owner making complaints which involve these factors is asking too much of his receiver and requires a better receiver to meet his needs.*

**Common Trouble.** The simplicity of the circuits used in A.C.-D.C. T.R.F. receivers greatly limits the variety of troubles which may develop. The complaints which will most often be encountered are: *Set is dead; local signals are weak; hum is excessive; set distorts; oscillation (squealing) exists; set operates intermittently.*

**Servicing "Dead" Receivers.** When the receiver is "dead," determine first of all if the tubes light or warm up. An open-circuit somewhere in the series filament circuit is indicated if they do not. Take out each tube in turn and check its filament prongs with an ohmmeter for continuity or test the tube in a conventional tube tester. If tubes are OK, check the filament voltage-dropping resistor with an ohmmeter. If a ballast tube is used for this purpose, inspect its socket connections in order to determine between which prongs there should be continuity. If a line cord resistor is used, check with an ohmmeter between the line cord resistor lead and each prong on the wall socket plug in turn (the plug being removed from its outlet); with the power switch open, or one tube removed, there should be continu-

reversing the position of the line plug; proper polarity must always be observed on D.C.

A low rectifier-tube output voltage on A.C. operation is an indication of defective filter condensers. Check each condenser or condenser section in turn, by disconnecting one of its leads and then checking the condenser for leakage with an ohmmeter. If leakage resistance is lower than the normal value for a condenser of similar size, the condenser is defective and requires replacement. Even if leakage resistance is normal (check the leakage resistance of a new condenser of about the same size for comparison if you are uncertain), the condenser may still have deteriorated through drying out of the electrolyte, with a resultant lowering of its capacity. Try a new filter condenser at each position in turn, while the old unit is disconnected. Separate 8-mf., 475-volt test condensers should be kept on hand for tests like this on any receiver. If the rectifier-tube output voltage comes up to normal when a new condenser is inserted, this is a sign that the old condenser was defective.

Even when only one section of the old electrolytic filter condenser is bad, a new block should be installed, for there is a good possibility that the other sections of the block will soon fail in a similar manner if left in the receiver. When using a test electrolytic condenser in this manner, you must, of course, observe polarity very carefully, for connecting an electrolytic condenser to a voltage source with improper polarity will in most cases ruin it.

If the rectifier tube output voltage of the "dead" receiver is normal, check the D.C. voltages between the "B—" point in the circuit and each plate and screen-grid prong of each tube. Repeat this test for the corresponding tube socket lug; failure of the two readings for any one tube electrode to correspond indicates a break between the lug and the tube socket prong connection, making the installation of a new socket necessary.

Improper voltages on any tube electrode will point to the source of trouble, just as in the case of an ordinary A.C. receiver. The circuit diagrams in this article will give you an idea as to what voltages to expect; obviously the detector tube plate voltage and the control-grid voltage on the power tube will be quite low due to the high values of resistance in these circuits.

Simple continuity checks of various receiver circuits often prove the speediest way of locating trouble in a "dead" receiver. There should be continuity between the rectifier-tube cathode and the plates, as well as screen-grids, of all other tubes in the receiver, with the exact ohmmeter reading depending upon the sizes of the resistors in the various circuits. There should be continuity from the receiver side of the ON-OFF power switch to the control-grids, as well as the cathodes, of all tubes in signal circuits.

Rotor and stator plates of tuning condensers are sometimes shorted together; inspection will often reveal such a short, but if doubts exist, disconnect the coil lead from the stator of each section and check each section individually with an ohmmeter. There should be no continuity between rotor and stator plates of a section.

To check the bias resistors in the cathode leads of the detector tube and the power tube, first disconnect the electrolytic cathode bypass condensers and then check the resistor with an ohmmeter. These condensers

(Continued on page 242)

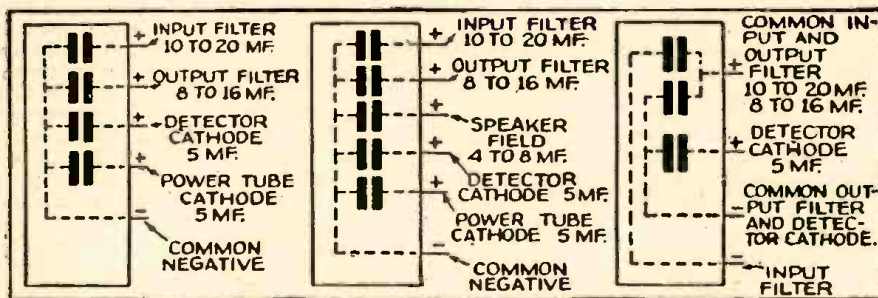

Typical connections for the electrolytic condenser blocks used in midget A.C.-D.C. sets.

now gives you the necessary data for ordering a replacement unit. If a unit having the desired internal connections and desired capacities is not available, the next best thing is to order a condenser block having the desired capacities and separate leads for each section. If even this is not available, make up your condenser block from two or more separate electrolytic condenser units having the desired capacity and voltage ratings. When ordering separate units in this way, be sure to check the available space and choose units which are small enough to fit this space.

## JUSTIFIED COMPLAINTS

*Is the Owner's Complaint Justified?* The operating characteristics of an A.C.-D.C. receiver of the T.R.F. variety must be care-

ty between one of the prongs on the wall plug and the receiver end of the line cord resistor if this resistor is OK. If there is a shunt resistor across the pilot lamp or lamps, check this with the ohmmeter for continuity. Check pilot lamps also for continuity.

If the set is dead but all tubes light up and test OK, use the D.C. voltmeter section of your multimeter to measure the voltage between the common rectifier-tube cathode connection and the tuning condenser frame (this always being at "B—" potential and convenient to reach with a test probe). With the set plugged into an A.C. outlet, you should measure between 90 and 120 volts, while with the set plugged into a D.C. outlet, this voltage may be as low as 85 volts. If no voltage is measured here on D.C., try



**PORTABLE RECEIVER POWER PACKS**

(Continued from page 225)

to any desired value from 0 to 1,000 ohms.

The bleeder, B2, serves two purposes. It acts as a safety for the output condenser. Should the pack be turned on with the set turned off, the terminal voltage cannot rise higher than 10, while without it the terminal voltage would be around 100. It also makes it possible to operate 6-volt and 1.4-volt receivers within the range of the 1000-ohm variable resistor. The bleeder takes about half the current on 6-volt sets. On the 1.4-volt sets, where more current is required, the amount taken by the bleeder is very small. This resistor is rated at 2 watts.

The plate supply goes through the usual midget receiver choke, with a 20-mfd, 150-volt (or higher rating) condenser on the output side. On the input side, one 20-mfd condenser is used for both plate and filament filtering. The output condenser in the filament circuit is a 100-mfd, 25-volt unit. The hum level on a 6-volt portable was very low, though on 1.4-volt sets drawing heavy currents, where R1 is set at a low value, it might be advisable to increase the input capacity to 40 mfd., and the output filament circuit condenser as stated in the description of the dry-rectifier pack.

A-minus and B-minus are common. Many portables bring these two terminals to ground. Others have a resistor in the B-minus lead to furnish "C" bias for the output tube. In sets of this type, distortion would result if a common A and B negative were used. Possibly the easiest way out would be to use a "C" battery in the pack, as shown in Fig. 4. Make sure the "on-off" switch so breaks the circuit that the "C" battery doesn't discharge continuously through the resistor between A-minus and B-minus. If the switch doesn't break this circuit, take out the resistor.

Move cautiously when hooking the pack up to a set—1.4-volt tubes blow out on the slightest provocation. Set all resistors to their highest values, and put a voltmeter across the filament terminals. Then decrease resistance gradually till voltage is correct.

As will be seen from the photos, the packs were mounted on a ply-wood base. This was simply the experimental hookup—the original idea was to put them on a sheet of crackle-finished iron to match the case as soon as the final hook-up was arrived at. Thus we expected to gain a neat appearance and the underwriters' approval in one operation. The present plan, however, is to install the packs in cases the exact size and shape of portable batteries, to fit inside the radios on which they will be used. Probably the switch will be wired up to the switch on the set.

No parts list is given, as the values of all parts are marked on the schematics.

With these two types of packs, the serviceman should be able to power practically any type of receiver brought to him for electrification.

RADIO-CRAFT would be glad to hear of any problems that may rise in converting portable receivers. Also—since many servicemen have no doubt worked out their own technique—we would be glad to hear of any packs more efficient or versatile than those described, or possessing any other special features. No doubt you have run into problems different from those presented here, or have worked out simpler and more efficient methods of solving them. Now is the time to let the world know what you have done.

Tell us about it, and give your fellow servicemen the benefit of your experience!

RADIO-CRAFT for JANUARY, 1943

**NATIONAL UNION SHAKES A  
Powerful Electronic Fist  
RIGHT IN DER FUEHRER'S FACE!!!**



**WE'VE FLEXED OUR PRODUCTION  
MUSCLES  
WE'VE CLENCHED OUR ENGINEERING  
FIST AND RIGHT  
AT THIS MINUTE  
WE'RE AIMING OUR UPPER-  
CUT RIGHT TO THE  
UGLY AXIS FACES.**

RADIO TUBES, TRANSMITTING TUBES, CATHODE RAY TUBES—THEY'RE ALL POURING OUT FROM OUR DOORS TO FIGHT DESTRUCTION OF OUR ENEMIES. YOU WOULD BE PROUD TO KNOW THAT YOU ARE A NATIONAL UNION ASSOCIATE IF WE COULD TELL YOU HOW VITALLY OUR PRODUCTS ARE COUNTING IN THE WAR EFFORT.

**ON THE HOME FRONT**

**NATIONAL UNION** Distributors, service men, dealers—all are fighting along with us to keep the domestic market open to keep home receivers in operation. N. U. tubes, condensers, volume controls—yes, even panel lamps, and other N. U. products, are counting now more than ever before. Every single unit which goes into a set today keeps the ears of the nation opened. We're proud of the distributors and service dealers who are helping in the war effort, and assure them to the last man that National Union appreciates your problem. National Union is doing everything humanly possible to help you solve it.



**NATIONAL UNION RADIO Corp**

57 STATE STREET, NEWARK, NEW JERSEY

**"FLAME THROWER" ON THE  
PRODUCTION FRONT**

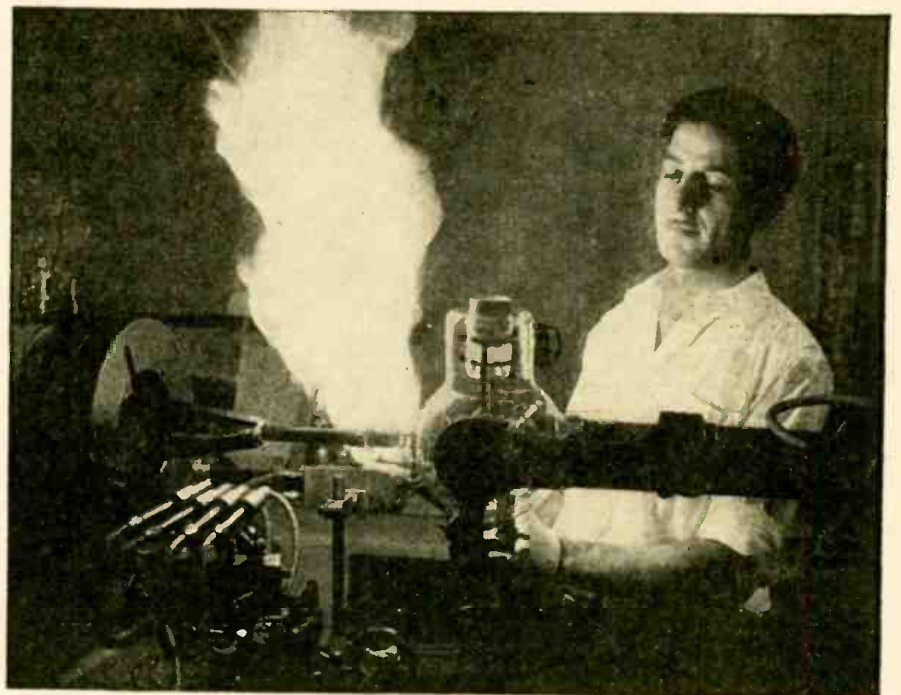

**S**EALING the end of a high power radio transmitting tube is done at the Westinghouse Lamp Division by this "cannon burner."

As the big tube rotates on a lathe the gas flame of more than 1,000 degrees

Fahrenheit melts the end of the glass bulb to make an air-tight seal. Manufacture of such tubes has been greatly accelerated owing to the importance of communication in modern war and American industry is keeping pace with the demand.



# QUESTION BOX

By FRED SHUNAMAN, Technical Editor

### QUERIES

All queries should be accompanied by a fee of 25c to cover research involved. If a schematic or diagram is wanted please send 50c. to cover circuits up to 5 tubes; for 5 to 8 tube circuits, 75c; over 8 tubes, \$1.00.

No picture diagrams can be supplied.

Back issues 1942, 25c each; 1941, 30c each; 1940, 35c each.

Any issue, prior to 1940, if in stock, 50c per copy.

? How would you hook up a microphone, (carbon, also crystal), to a radio for P. A. use, also a phonograph pickup and tone and volume controls? The radio has a 6C6 detector tube.—R. S., Teaneck, N. J.

### HOOKING UP A MICROPHONE

If a crystal, use a lead direct from the mike itself. The other lead is grounded in both cases. If a crystal mike is used, a one-megohm resistor will have to be placed across it to provide a D.C. grid return.

ume control in the R.F. circuits of the receiver, so that when the mike or pickup is on radio may be cut out by turning down the control.

Phono or mike volume may then be controlled by a volume control shunted across the output of the pickup or mike transformer, with one lead to the set attached to the movable arm. (See Fig. 2.)

The control may be 50,000 ohms for low-impedance devices, and .5 megohm, or recommended load, for crystals.

For sets with diode detection, the hookup in Fig. 3, is recommended. All leads should be well shielded and the shield well grounded. The shield is usually used as the lead from the phonograph or microphone to ground at the radio, marked "G.L." in the diagram. "X" marks the point where the original winding was broken to attach the device.

If radio signals filter through in any of these arrangements, it is usual to break one of the I. F. cathode circuits, thus effectually killing the R.F. end of the set.

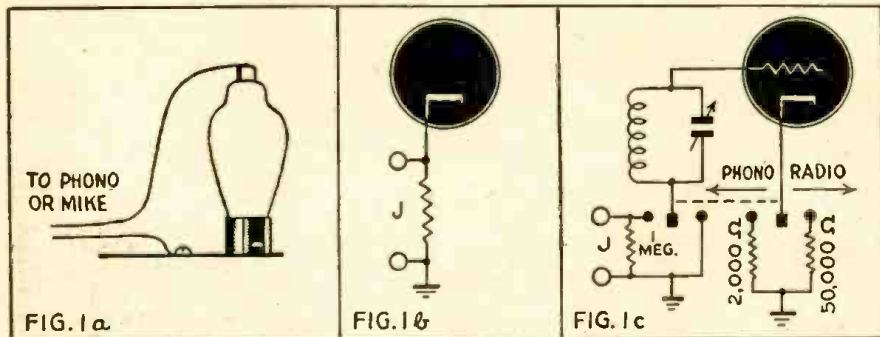

A. The simplest method of hooking a microphone to your set is to remove the detector grid cap and replace it with one of the leads from the secondary of your

The volume control may be used as this resistor.

This system is shown in 1A. Its chief disadvantage is that the cathode bias of a detector is usually too high for good reproduction of moderately strong signals.

Fig. 1B shows a second system, suitable for low-impedance pickups and microphone transformers. It brings the cathode bias down to a few hundred ohms, depending on the device shunted across the bias resistor. This is too low, especially if the detector has a high resistance in the plate circuit. Fig. 1C is the ideal hookup for this type of receiver. A double-pole double-throw switch makes it possible to insert the mike or pickup in the grid circuit at the best point, and at the same time change the cathode resistor to one suitable for amplification.

These three methods presuppose a vol-

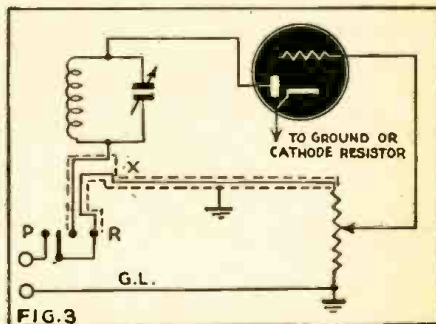

For tone control, see circuits in *Radio-Craft* June, 1942, Page 608, and Aug-Sept., Page 736.

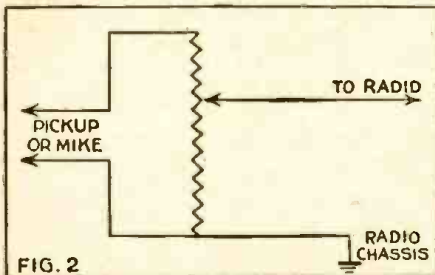

microphone transformer if you are using a carbon mike.

### "PIGMY RECEIVER"

? Where can I get diagram, constructional information and coil data for the one-tube "Pigmy Receiver" which used a 117L7-GT tube?—Several Readers.

A. This circuit appeared in the issue of June, 1940, copies of which are no longer available. Herewith the hookup and parts list. Note that a "Safety First" method of

plugging in is used. Only one wire goes to the A.C. wall outlet, and the chassis is thoroughly grounded. If the plug is put in wrong, the set will not light—turn it around.

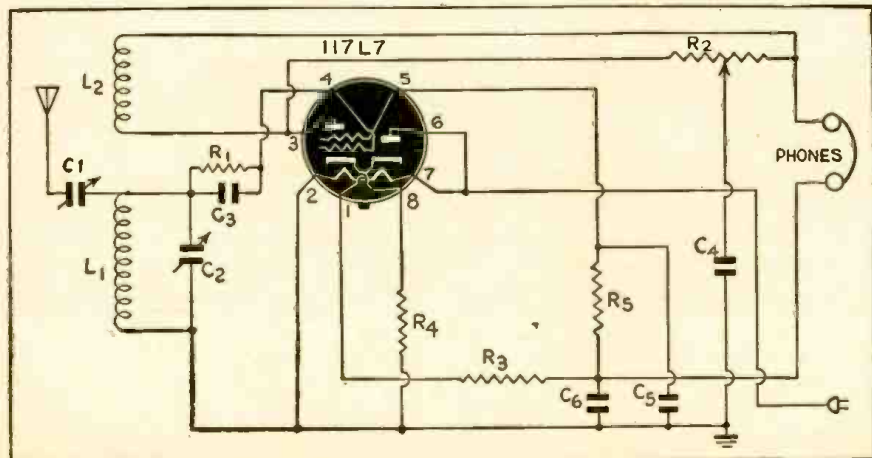

#### Parts List

- C1—Mica trimmer, 3-35 mmfd.
- C2—19 plate 140 mmfd. variable condenser
- C3—Mica condenser, .0001 mfd.
- C4—Mica condenser, .005 mfd.
- C5, C7—Paper condensers, .1 mfd.
- C6—Electrolytic condenser, 40 mfd., 150 volts
- R1, R5—1 megohm, 1/2 watt fixed resistor
- R2—75,000 ohm potentiometer
- R3—10,000 ohm, 1/2 watt fixed resistor
- R4—150 ohm, 1/2 watt fixed resistor
- 1—117L7-GT; 1—octal socket for same, 1—four-prong or six-prong socket, according to type of plug-in coils used; 1 pair headphones; phone jacks, line cord and plug, knobs, dials, hook-up wire, etc., chassis and cabinet as desired.

#### Coil Data

Any set of standard plug-in coils may be used, or they may be wound to the following specifications:



Range (Meters)	L1 (Turns)	Length of Winding	Size Wire	L2
15-30	8	1½ in.	18	5
30-70	18	1½ in.	18	7
70-150	40	1¾ in.	28	15
150-300	80	1¾ in.	28	20
300-550	150	1¾ in.	30	35

Coil form diameter 1½ inch. All L2 coils close-wound with No. 30 or 32 wire. All wire enamel covered.

Input and Output Connections

**?** Please explain input and output connections on the Push Pull Direct-Coupled 10-Watt Amplifier described in the July, 1939, issue, and show how to add volume and tone controls to this circuit.—Several Readers

**A.** The two jacks are for three-conductor mike or phono leads, as from a double button mike, or an ordinary pickup with a shielded cable. The shield, or third conductor is grounded—the other two make

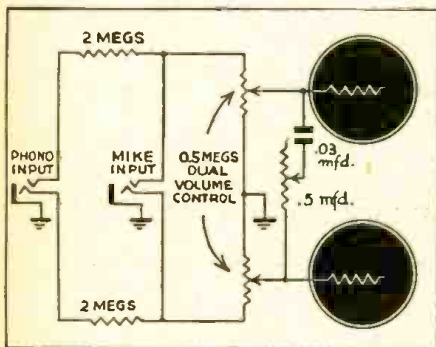

connections to the grids of the first two tubes. The three points shown as "Output" are for connection to the primary of any push-pull output transformer suited to the 6L6's.

Volume and tone control connections are shown.

Note that the 0.5 megohm dual volume control replaces the two 0.5 meg gridleaks of the first two tubes.

2-4 Tube Progressive Receiver

**?** I am having trouble with the 2-4 tube Progressive Receiver (June and July Radio-Craft). I cannot get it to oscillate, and signals are very weak.

I am unable to get the set of plug-in coils and have wound my own. Would appreciate specifications of correct coils.

A. G. Verdun, Quebec.

**A.** Several things may cause your set to refuse to oscillate:

- 1—Your coils, as you think, may be wrong. (See specifications for Pigmy Receiver coils in this month's Question Box).
- 2—Your tube may be poor. Have it tested at a reliable radio shop.
- 3—Tickler may be backward. Reverse the connections.
- 4—By-pass condenser may be defective. Try another, possibly a little bigger one. (.00025)
- 5—Plate resistor may be too high. 50,000 ohms should be right. Check by substituting another.
- 6—Combination of circumstances—circuit wiring, etc.—may require tickler bigger than specified. Wind on a few more turns.

We trust that one of these suggestions may discover the fault in your receiver.



Meissner employees are justifiably proud of their "E" emblems... the symbol of a job well done.

BETTER A.V.C.

Many radios do not have sufficient A.V.C. action, due to not enough voltage being produced across the diode-to-cathode load resistor.

Here is a circuit previously used as a voltage-doubling power rectifier utilizing a 25Z5 tube, but which can be adapted to the task of diode detection, using a 6H6 in a voltage-doubling diode detector.

Due to the added bias fed back to the R.F. and I.F. tubes and the resulting decreased gain, the voltage across the diode load will not actually be doubled, but more uniform A.V.C. action will be had with increased A.F. output.

It would be well to reduce the minimum bias on the R. F. tubes to compensate for

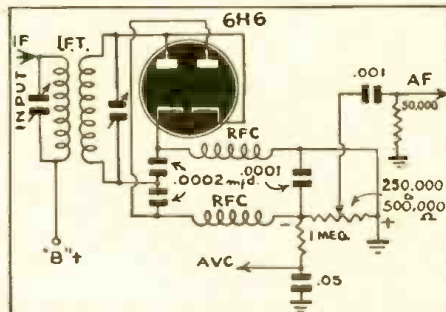

the increased A.V.C. bias applied to them.  
HAROLD GIBSON,  
Granger, Indiana



*Diagrams for*

**The Radio Experimenter**

If you have a new Hook-Up, send it along; a pencil diagram will do. Be sure to include a brief description.

All diagrams and descriptions accepted and published will be awarded a year's subscription. Diagrams may be for receivers, adapters, amplifiers, etc. Send them to Hook-Up Editor, RADIO-CRAFT, 25 W. Broadway, New York City.

**SELECTIVE OSCILLATOR**

Herewith is a diagram of an oscillator circuit (Fig. 1) that I have found to give remarkable selectivity, and extremely small drift.

It uses regeneration through the tuned circuit LC, and since the grid-plate capacity of any pentode (R.F. pentode) is very small, the detuning effect of it is negligible, and the frequency of oscillation is not changed by tube conditions.

Condenser C1 is needed to keep high

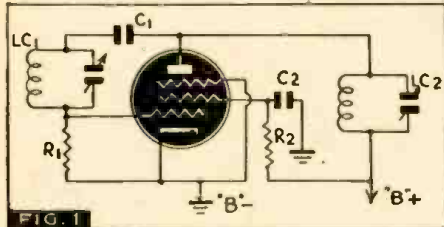

voltage from the coil and condenser, and should be a small mica (.00025 or .00005).

Resistor R1 gives grid leak bias and should be about 1 megohm. R2 is a screen voltage dropping and decoupling resistor, along with C2.

LC2 has no effect on oscillator frequency, but controls amplitude of oscillation and output.

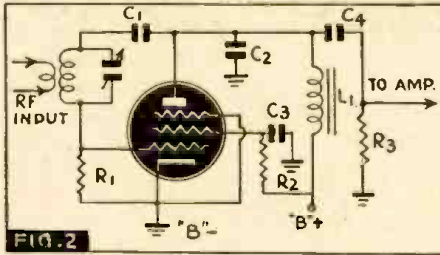

Typical values or parts using 6J7 with 250 volts plate supply are:

- RESISTORS**  
 R1—1 meg., ½ W.  
 R2—250,000 ohm (½ W)  
**CONDENSERS**  
 C1—.001 mf., 600 V.  
 C2—.01 mf., 400 V.

This circuit can be made into a regenerative detector as shown in Fig. 2.

**PARTS LIST**

- RESISTORS**  
 R1, R2—1 meg.  
 R3—10 meg.  
**CONDENSERS**  
 C1—20 mf., variable to control regeneration  
 C2—.0001 mf., 600 V. mica  
 C3—.01 mf., 400 V.  
**MISCELLANEOUS**  
 L1—700 henry audio choke  
 L2—700 Henry audio choke

THOMAS F. SCHWARTZ,  
 New York, N. Y.

**PHONO OSCILLATOR**

Here is a schematic diagram of an A.C.-D.C. Phono-Oscillator that I recently designed, and constructed almost entirely from parts salvaged from a late model midget broadcast receiver.

Although I used the output transformer and speaker from the broadcast receiver,

with gratifying results, superior performance may be achieved by employing one of those special voice coil-to-grid matching transformers now available.

A type 12SJ7GT tube was selected to amplify the output of the mike, since this tube  
 (Continued on following page)

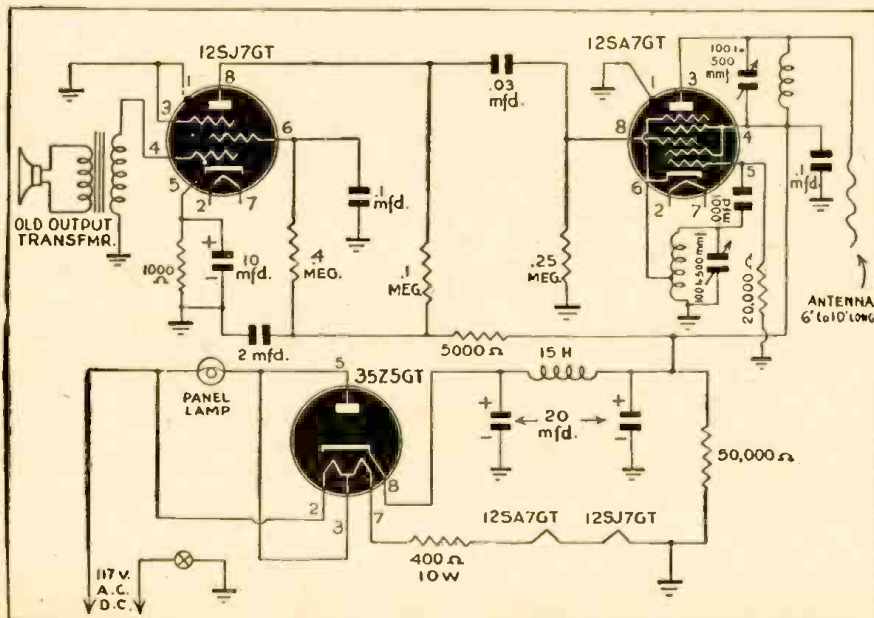

**MICROPHONES EXPLAINED FOR THE BEGINNER**

(Continued from page 231)

remain magnetized for a long period of time.

The moving coil microphone is quite rugged and is not affected by climatic conditions. Its output level is approximately 10 db. higher than that of the condenser-type microphone, or about -80 db.

The low impedance of the dynamic microphone makes it possible to locate the pre-amplifier some distance from the microphone itself.

The frequency characteristic of the dynamic microphone is quite uniform from 35 to 10,000 cycles, so it has very good fidelity response to sounds in the normal audio range. This type unit has no inherent noise, and due to its very rugged construction can stand quite a bit of rough handling.

**CRYSTAL MICROPHONES**

Two types of crystal microphones are in common use today, to wit: 1st, the *sound-cell* type (See Fig 1G.) in which the sound waves act directly upon the crystal; and 2nd, the *diaphragm* type (See Fig 1F.) which uses a diaphragm to the center of which the crystal is attached by means of a mechanical link.

In either of these units, the principle of operation depends upon the piezoelectric effect or voltage produced in certain crystals when subjected to mechanical stress (bending, etc.).

The *sound-cell* unit is an assembly of 2 "bimorph" Rochelle salt crystal elements in a bakelite frame. The bimorph elements, in turn, are each made up of 2 crystal plates with electrodes attached, cemented together so that an applied sound will cause a bending of the assembly, and produce a voltage. The mounting is such that mechanical shocks have little effect on the unit.

No diaphragm is used, the sound impulses actuating the crystals directly. An exceptionally wide frequency range, even into the super-audible band and on down to zero frequency, may be obtained from this unit.

Of the 2 types of crystal microphones, the sound cell has the better frequency characteristics. Its output is very low, however, so it requires greater amplification. This type of crystal microphone is usually employed for full-range musical pick-up.

The *diaphragm* type will give much greater output, eliminating in most cases the need for a preamplifier, but it has the disadvantage of a limited frequency response. This type of crystal microphone is used mostly for voice work.

**HOW TO HOOK UP RADIO RECORD PLAYERS**

(Continued from page 215)

phono connections made there, the results would be satisfactory for the player, but would detune the radio.

It will be seen that although the secondary of the last I.F. coil offers a high impedance to R.F. there will be negligible impedance to A.F., and we can therefore consider this coil as a piece of wire so far as A.F. is concerned.

With this in mind the circuit can be broken at the grid-return end of the coil and the proper connections made.

Volume must be controlled from the control in the record player.

To make correct connections to T.R.F. receivers with power detection, use the same ideas as just described.



**PHONO OSCILLATOR**

*(Continued from previous page)*

provides much more overall stage amplification than any other type tube available. This was deemed necessary in consideration of the fact that the reversed speaker would provide small audio frequency current.

I first considered using a large inductance radio frequency choke in the plate circuit of the mixer tube, but discarded the idea when it occurred to me that such an arrangement would actually offer higher impedance to the second harmonic than it would to the fundamental frequency of 540 kilocycles. This would probably have resulted in the occurrence of an unwanted signal in about the middle of the receiver dial. I therefore decided to use a tuned circuit in the mixer plate circuit to insure maximum impedance to fundamental frequency.

Both coils may be wound with No. 28 enamel wire on one inch by two and one-half inch coil forms. Each coil consists of 135 turns, but the oscillator coil is tapped 44 turns from ground end for the cathode lead.

The tuning condensers are of the trimmer type with maximum capacity of 500 mmf.

Because this set cost me only about \$1.50 for parts I was unable to salvage from a broadcast midget, I would like to pass the idea along to other experimenters.

JOHN E. HAZELRIGG,  
Holden, W. Va.

**CODE PRACTICE OSCILLATOR**

This diagram shows an "A.C. OPERATED CODE PRACTICE OSCILLATOR," made from old junk parts. The filament transformer is an old speaker output transformer.

When 115v. is applied to the high impedance primary the secondary develops 2 to 3 volts. This takes care of the two 27's in parallel. In this way no voltage-dropping resistor is necessary for the filaments.

The unit I made was built on an inverted cheesebox with miniature jacks for the

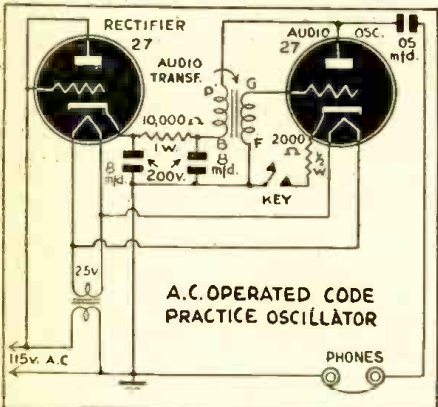

phones and key. The tone is very satisfactory.

If a filament transformer for 6.3 volts is available substitute 6CS's or 76's for the 27's.

If the oscillator doesn't perk, try reversing the audio transformer leads on the secondary.

The audio transformer, by the way, can be any ratio. It's an ordinary inter-stage transformer. If the audio note is too high place a .00025 condenser in parallel with the grid circuit.

Changing the cathode resistor slightly will also change the tone. NOTE: Be careful not to ground the apparatus with a physical ground, since one side of the AC is used in the set.

DAVID GNESSIN,  
Grand Rapids, Mich.

**R.F.-A.F. AND POWER SUPPLY UNIT**

Meet the 2X4! It is a combination R.F. and A.F. amplifier and regenerative receiver and power supply.

S3 is for switching the antenna from the regenerative R.F. amplifier to the receiver it is used with.

Coil forms used are 5-prong, to accommodate the tapped tickler which may be necessary because of different reactions between receiver and R.F. amplifier connections.

R2 and C5 are mounted in octal tube base pins 2-8. Pins 4 and 5, 7 and 8 are shorted. R1 and C4 are mounted under the chassis on socket lugs 4 and 5. Other connections are as shown.

S1 and S2 are in position for R.F. amplifier connection and audio input connection. Throw switches and it is a regenerative receiver. R.F. output is shorted for receiver connections. S3 is antenna change-over.

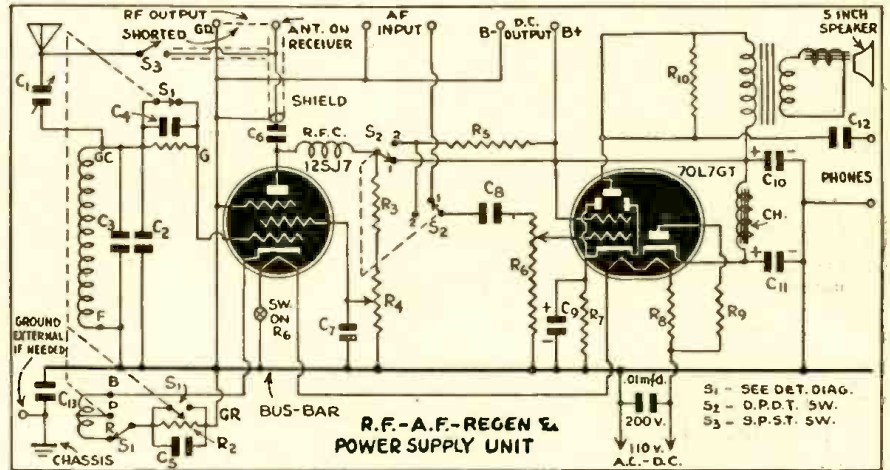

An ingenious switching arrangement permits numerous tests with this set-up.

**Parts List**

**CONDENSERS**

- C1—3-30 mmf.
- C2—140 mmf.
- C3—35 mmf.
- C4—.0001 mfd.
- C5—.1 mfd., 200 V.
- C6—.0005 mfd.
- C7—1 mfd., 200 V.
- C8—.06 mfd., 200 V.
- C9—10 mfd., 25 V.
- C10—16 mfd., 150 V.
- C11—40 mfd., 150 V.
- C12—.1 mfd., 200 V.
- C13—.1 mfd., 200 V.

**RESISTORS**

- R1—3 meg., 1/2 Watt
- R2—1000 ohms, 1/2 Watt
- R3—.1 meg., 1/2 Watt
- R4—50,000 ohms
- R5—.25 meg., 1/2 Watt
- R6—.25 meg.
- R7—200 ohms, 10 Watts
- R8—250 ohms, 10 Watts
- R9—50 ohms, 1/2 Watt
- R10—2,000 ohms, 10 Watts if speaker is not used.

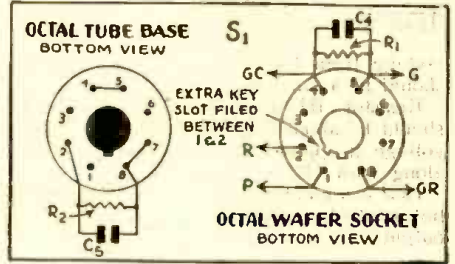

**MISCELLANEOUS**

- S1—Tube base and socket
- S2—D.P.D.T. Switch
- S3—S.P.S.T. Switch
- Ch.—25 henry
- R.F.C.—2.5 mh.

ROBERT VADNEY,  
Waterliet, New York.

**SHORTWAVE SUPERHET.**

This is just the set for the short wave fan or ham who is tired of the regenerative set and wants something with more "pull-em-through" ability. The set is easy to build and is not very draining on the pocket-book, the cost being about \$12.

The circuit uses a 6A7 as mixer; a 6K7 as second detector; and a 6K6G as output. Only one I.F. transformer is used, but this one has an iron core and has plenty of gain.

The usual building procedure should be used, making sure to have short leads to the plates and grids.

Either a single wire or a doublet antenna can be used; make sure to use a good ground. Tuning is done with the oscillator controls. The 15 mfd. variable condenser is used for bandspread.

Regular coils are used which cover from  
*(Continued on following page)*

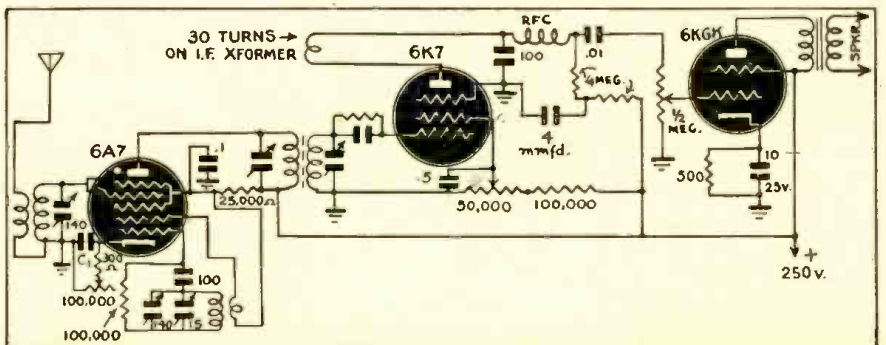



# RADIO HOOK-UPS

(Continued from previous page)

9 to 560 meters. Be sure to shield the oscillator coil.

The results with the receiver have been very good. In the last few months I have logged the seven continents—VLO5—ZRL—RNE—HCJB—WCBX—XGOX—KC4USA.

HAROLD HELD,  
Paterson, N. J.

## SUPERREGENERATIVE RECEIVER

The diagram below shows a receiver which I have tried, and found works satisfactorily.

When I first considered getting on 2½ meters I drew up a few diagrams and decided on the simplest form of superregenerative receiver. The results were not what was to be expected so I changed the circuit to its present state by adding a few parts and making coil changes. I feel sure that

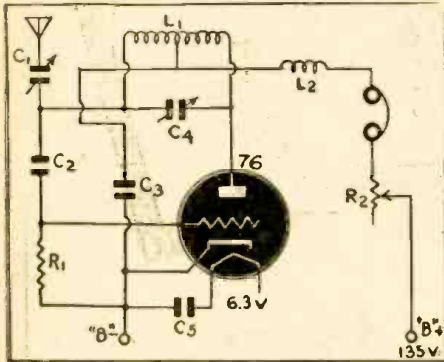

none of your readers will have difficulty in getting the set to operate.

When I was contemplating building the receiver I was under the impression that for 2½ meters one needed all high-priced doodads. I had all the parts in the junk box except the tube, so the set cost me a total outlay of 50c.

On 2½ meters I heard only one station as my location is only about 20 feet above sea level, and the nearest active ham from

my location on that band is 7 miles away. On five meters I had good luck, having heard the W1, W2, W3, W4, and W9 call areas. I use a 48 inch, vertical antenna about 50 feet from the ground. The antenna is coupled to the set by 50 feet of twisted hair.

On the 9 meter police band the results were much more than I expected. I hear all the local and many distant police calls. The city of Linden transmits on 9 meters, and they come in on a loud speaker when hooked up to this set.

The volume control is needed for comfortable reception on the stronger signals. If the set has feedback, and howls, a .01 mfd. condenser across the fones will usually stop it. However, the .01 mfd. condenser cuts down the volume quite a bit.

The condenser on my set is insulated from the tuning dial by a 3-inch dowel.

I am sure your readers will experience no difficulty in assembling the set.

### Parts List

#### CONDENSERS

- C1—30 mmf.
- C2—.0005 mfd.
- C3—.002 mfd.
- C4—15 mmf.
- C5—.005 mfd.

#### RESISTORS

- R1—500,000 ohms
- R2—10,000 ohms

#### MISCELLANEOUS

- L2—R.F.C.—20 turns, ¼ inch form. Dimensions for L1—2½ meters, 5 turns, ¼ inch in diameter. Five meters, 10 turns, 7/16 inch in diameter. Seven to Nine meter police, 18 turns, 7/16 inch diameter. Ten meters, 20 turns ½ inch diameter. All coils should be No. 16 wire.

ARTHUR E. MACK,  
Linden, N. J.

## POWER SUPPLY CIRCUITS

Sometimes we want a power supply that need not be large and bulky, but just enough to give 45 to 65 volts. A great many portable radios, on which a lot of us are working lately, demands such an outfit.

It is possible to make up such a power supply by using old transformers or parts from B-battery eliminators, etc.

Fig. 1 shows how a 117-volt rectifier is

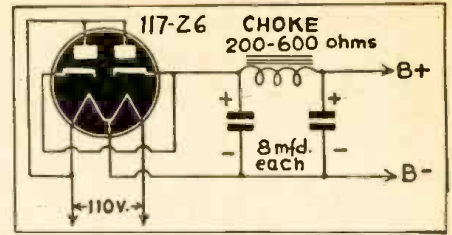

Fig. 1

A simple A.C.-D.C. supply using a 117-volt rectifier.

used full-wave on an A.C.-D.C. hookup, to supply B-plus voltage.

Fig. 2 shows a power supply that can be

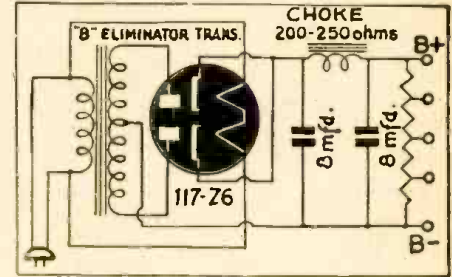

Fig. 2

Power supply with old Majestic transformer and 117-volt rectifier to operate off A.C. only.

constructed from an old Majestic type B-battery eliminator transformer, which has only the plate winding, and a 117-volt primary. Full-wave rectification is used in this also.

As can be seen in the diagram the circuit is very simple and inexpensive to construct.

PVT. CARL H. SCHUPPEL,  
Fort Sheridan, Illinois.

## CONVERTING AUTO RADIOS

With the production of new radio receivers stopped for the duration, the serviceman is given the opportunity of putting his ingenuity to work keeping the present receivers operating, as well as bringing the older sets up-to-date, where parts for doing so are available.

There will likely be a shortage of the small A.C.—D.C. sets that were so common as Christmas presents. There are a number of used automobile sets (especially those with synchronous vibrators) that can be

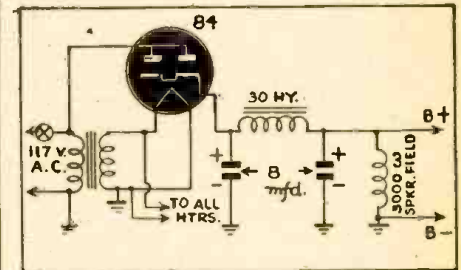

converted into A.C.—D.C. receivers with little work.

The synchronous vibrators cost so much that a number of sets have been discarded. Yet the receiver and the tubes are usually O.K.

By replacing the vibrator transformer with a doorbell transformer and the vibrator with an 84 tube, the receiver can be changed over to A.C.—D.C.

The tuning condenser shaft will have to be lengthened, and a dial provided,—but that is not beyond the ability of the average experimenter.

E. E. YOUNGKIN,  
Altoona, Pa.

# SPECIAL

### ABC OF TELEVISION

Contains latest material on television developments. It covers theory of scanning; simple television receiver; how the eye sees; the photoelectric cell; neon lamps; need for broad channel width in transmission signals; cathode ray tube and television receivers; Farnsworth system; and other important features.

### SHORT WAVE GUIDE

Covers hundreds of short-wave questions and answers; illustrates popular short-wave kinks; gives explicit instructions for building simple short-wave receivers; instruction on the best type of antenna installation; diagram and construction details for building transmitters.

### S. W. RADIO QUIZ BOOK

This book covers questions and answers on transmitters, ultra short-wave receivers, practical kinks, wrinkles and coil winding data; novel hook-ups for experimenters; how to "hook-up" converters; noise silencers; beaters; modulators; antennas; oscillators; 5-meter receivers; selectors.

The books listed below have never been sold by us before. The value of each book is 50c. They are exactly the same as RADIO & TELEVISION'S 50c blue books which have been on the market for years.

For a short time only we are selling these at a special reduced price of only 75c for the 3 books.

All of the books contain numerous photographic illustrations and diagrams and have stiff flexible cover.

RADIO & TELEVISION  
25 W. Broadway,  
New York, N. Y.

Gentlemen:  
Enclosed you will find remittance for 75c (cash, new U. S. stamps or money order accepted) for which please send me at once your 3 books  
ABC OF TELEVISION SHORT WAVE GUIDE  
SHORT WAVE RADIO QUIZ BOOK  
PLEASE PRINT CLEARLY

Name .....

Address .....

City ..... State ..... RC-1-43



# OFF THE PRESS!

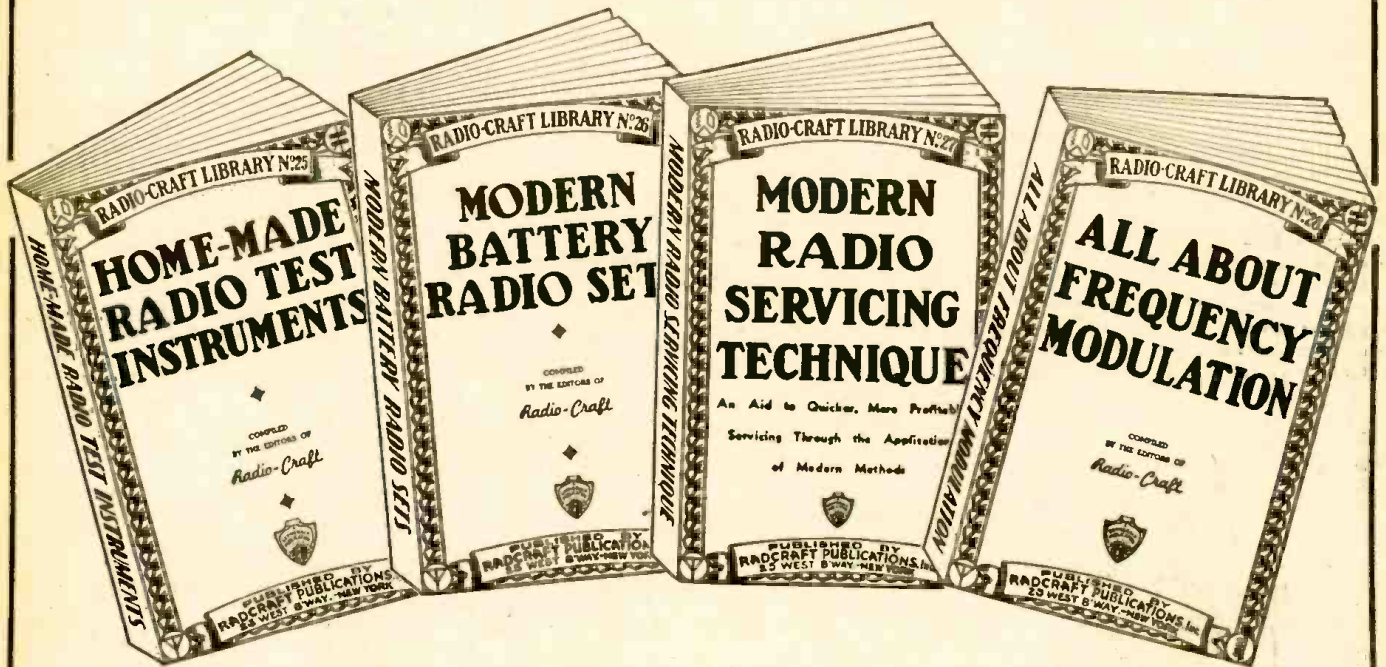

## New RADIO-CRAFT Library Books

THE four latest books of our well-known RADIO-CRAFT Red Books—Nos. 25, 26, 27 and 28—have just come off the press. These four books are all on timely subjects and we recommend every one of them to you strongly.

Now, more than ever, radio education has become a burning question. If you are to be in the National Service, in the Army, Navy or Air Force—practical radio knowledge is of paramount importance. YOU CAN GET BETTER RATINGS AND ADVANCE QUICKER IF YOU HAVE A GOOD RADIO BACKGROUND.

Conversely, if you are not with the armed forces, there is a whale of a job to be done at home. With more and more men going into the service, the demand for practical servicemen becomes greater each day. Therefore we say: PROFIT BY THESE UNIQUE BOOKS, WHICH ARE PRICED SO LOW THAT THEY ARE WITHIN THE REACH OF EVERYONE'S PURSE.

### No. 25—HOME-MADE RADIO TEST INSTRUMENTS

This book includes articles covering a wide range of test apparatus of live interest to every radio man. Servicemen will find many circuits in this book to make their work more profitable. New ideas in test equipment make it possible to service radio receivers more quickly.

Laboratory workers and experimenters will find many articles which describe in detail construction and use of all essential radio test units—multi-meters, oscillators, stage-analysis testers, oscilloscope equipment, V.-T. voltmeters, etc. Even advanced technicians will be interested in the circuit arrangements showing the new and improved variations of well-known, basic test equipment. A MUST for every serviceman. This book contains 86 illustrations.

Outline of Contents: A Low-Cost Signal Chaser—Signal Tracer Test Unit—Simplified Practical Signal Tracer—A Home-Made Infinite-Resistance Tube Checker—Build This Direct-Reading V.-T. Voltmeter—How to Make a Modern V.-T. Voltmeter—Measuring High Values of A.C. Voltage and Current With a Low-Range Meter—How to Make a Meter-Range Extender—How to Build a Practical Tube Tester and Set-Analyzer Adapter—The Beginners' Simple Volt-Milliammeter—Build This Simplified Neon-Type Test Unit—Midcut Oscilloscope—How to Make and Use a Frequency Wobbler—Double Tracing Your Oscilloscope—Home-Made Frequency Modulator.

### No. 26—MODERN BATTERY RADIO SETS

Whether you are a radio man or a beginner, the articles in this book give you basic circuit arrangements or elementary radio receivers which serve the dual role of teaching the elements of radio reception, as well as making perfectly-operating 1- and 2-tube radio receivers. Picture diagrams and bread-board layouts galore.

Advanced radio set builders are offered more complicated arrangements. Laboratory workers and engineers will find in many of the articles circuit and constructional features which have become commercial practice. Many entirely new ideas are given in this book. One of the most important volumes we recently issued. This book contains 76 illustrations.

Outline of Contents: Beginner's 1-Tube High-Gain All-Wave Receiver—Beginners-Build This 1-Tube Loop Receiver—A "3-in-1" Battery Portable—An Easily-Built "Fluveling Superregenerative" 2-In-1 "Card File" Battery Set—A 2-Tube Superhet. With Pentagrid Regenerative 2nd-Detector—The 4-Tube Superhet. Vacation Portable—The "Lunchbox 5" Battery Portable—"The Seafarer" Loop-Type Boat Radio Set—4-Tube Permeability Portable—An All-Purpose Portable—A Typical Commercial 3-Way Portable (Pilot Models X-1452 and X-1453)—Switch for Varying "C" Bias on Battery Radio Sets—Making a Simple Portable Aerial—Making a Pilot-Light Fuse—Old Auto Sets for New Cars—Using a Loop Portable in Cars—Quasi-Electric Soldering Iron—Lamp Bulbs as Resistors.

### No. 27—MODERN RADIO SERVICING TECHNIQUE

Here is a book of great importance to every radio man, every radio engineer, and particularly all radio servicemen. A list of the contents which follows shows the importance of this book, literally jam-packed to overflowing with radio-meet. Whether you are a servicing beginner or whether you are an experienced serviceman—you will find many important helps in this volume.

Book is eminently practical and will solve many problems for you. More important: It will show you many short-cuts; all calculated to save your time and patience. Practical everyday data on standard receivers appears throughout the book. A whale of a book compressed into a minimum of space. Contains 98 important illustrations.

Outline of Contents: Elementary Servicing Technique—Correct Procedure for the Servicing Beginner—Elementary Procedure for Servicing Radio Sets—A.F.C. Alignment Made Easy—Dynamic Servicing—Dynamic Testing Simplifies Servicing—Modern Receiver Test Requirements—Servicing Universal A.C.-D.C. Receivers—Servicing "Orphans" and Private-Brand Sets—Emergency Servicing Without Test Meters—Servicing Coils—Servicing R.F. Coils—Servicing Oscillator Coils—General Information—RMA Transformer Color Code—What Causes Echo, Fading?—Radio Service Puzzlers.

### No. 28—ALL ABOUT FREQUENCY MODULATION

Here is a complete compilation of pertinent data on the entire subject of the new coming art of Frequency Modulation.

There is no question but that Frequency Modulation is already revolutionizing radio broadcasting in this country. Were it not for the war, there would now be a tremendous boom in this new art—yet, even with war restrictions imposed upon it, Frequency Modulation is still jumping ahead by leaps and bounds.

With Frequency Modulation no longer a theory—with hundreds of stations already dotting the land and with countless hundreds of others to come when peace is achieved once more—every radio man should read up and know all there is to know on this most important subject.

This particular handbook is chock-full with a tremendous amount of information which you probably will not find in any similar book in print.

Outline of Contents: The ABC of F.M.—Frequency vs. Amplitude Modulation—Basic Facts About F.M. Broadcasting—Construction—Build This Practical F.M. Adapter—Audio Amplification—F.M. Audio Amplifier, Part 1—F.M. Audio Amplifier, Part 2—F.M. Audio Amplifier, Part 3—F.M. Service—Part 1, Antenna Installation and Service—Part 2, Receiver Alignment and Diagnosis—Part 3, Test Equipment for F.M. Servicing, Engineering—Part 1, The How and Why of F.M.—Part 2, The How and Why of F.M.—Theory and Design Considerations of R.F. and I.F. Coils in F.M. Receivers.

### SPECIAL SEND-NO-MONEY OFFER

It is not necessary that you send money with order. If you wish to take advantage of our C.O.D. plan, simply cut out the coupon, paste it on a post card and send it to us. Books will be sent to you immediately. All four books are listed uniformly at 50c each. No discount on less than three books.

If you wish to take advantage of our special offer, ordering three books or more, we make an unusual low price to you as follows:

3 books—\$1.25  
4 books—\$1.50

Do not fail to send coupon today!

RADCRAFT PUBLICATIONS, INC.  
25 West Broadway, New York, N. Y.

RADCRAFT PUBLICATIONS, INC.		1-43
25 West Broadway, New York, N. Y.		
Gentlemen:		
Rush to me by return mail, as per your special offer, the following books: (Check books selected.)		
<input type="checkbox"/>	No. 25—HOME-MADE RADIO TEST INSTRUMENTS.	
<input type="checkbox"/>	No. 26—MODERN BATTERY RADIO SETS.	
<input type="checkbox"/>	No. 27—MODERN RADIO SERVICING TECHNIQUE.	
<input type="checkbox"/>	No. 28—ALL ABOUT FREQUENCY MODULATION.	
I will pay postman \$1.00 (if two books are ordered) plus a few cents postage and charges; \$1.25 for three books, plus a few cents postage and charges; \$1.50 for four books, plus a few cents postage and charges. WE CANNOT SEND A SINGLE 50c BOOK C.O.D.		
NAME .....		PLEASE PRINT CLEARLY
ADDRESS .....		
CITY .....		STATE .....
<input type="checkbox"/> Save shipping and C.O.D. charges! Check here if you send cash with order. (Cash, U.S. new postage stamps, money order, check.) Foreign countries no C.O.D. Add 20% to all prices quoted.		



# WHILE THEY LAST

All of the attractive items listed here are brand new. ALL are in PERFECT WORKING ORDER. In many cases, the parts alone total more than the price we are asking. 100% satisfaction guaranteed or your money refunded. ORDER FROM THIS PAGE. Use the convenient coupon below. Include sufficient extra remittance for parcel post charges, else order shipped express, collect. Any excess will be refunded. C.O.D. shipments require 20% deposit. If full remittance accompanies order, deduct 2% discount. Send money order, certified check, new U. S. stamps. No C.O.D. to foreign countries.

ORDER TODAY LIMITED QUANTITIES PROMPT SHIPMENTS ASSURED

## THE SODERWAND SUPER SOLDERING IRON

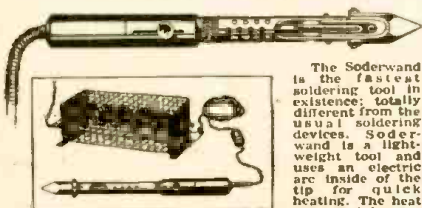

The Soderwand is the fastest soldering tool in existence, totally different from the usual soldering devices. Soderwand is a light-weight tool and uses an electric arc inside of the tip for quick heating. The heat generated by the arc is so intense the copier is hot enough to flow solder. There is a constant surplus of heat which makes quick soldering jobs seem easy. Current consumption is small, as only intermittent current is necessary to keep iron hot. Convenient thumb control cuts current on or off. Simple in design. Burn-out impossible as there is no heating element to burn out.

that within 60 seconds after starting. The Soderwand is an all-purpose tool that takes care of the heaviest or most delicate job with equal ease. IMPORTANT. This is a brand new item and comes in its original packing. We acquired the manufacturer's entire stock, which is the reason why we can sell the tool for so little money. THE ORIGINAL PRICE WAS \$5.00.

Supplied with regular No. 3 pyramid tips, 14 feet of cord, attachments, plugs, resistance unit, and two extra sets of carbons. Made for 110 volts A.C. 60 cycles, or D.C. Size: 13" long. Tool weighs 10 oz. Ship. wt. of outfit 4 lbs.

ITEM NO. 154  
YOUR PRICE ..... \$3.00

## VARIABLE SPEED UNIVERSAL MOTOR FOR 110 VOLTS, A.C. OR D.C.

Made for Dictaphone machines by American Gramophone Co. Used, but in excellent condition. Special lever control permits variable speeds up to 3000 r.p.m. 1/4" shaft extends from both sides of motor. Measures 7 1/2" x 3 1/4" diam. overall. Shp. Wt. 6 1/2 lbs.



ITEM NO. 614  
YOUR PRICE ..... \$2.95

## WESTON MODEL 662 A.C.-D.C. AMMETER

Designed by Weston for the Eastman Kodak Co. It is a Precision-built magnetic-vane type ammeter which, with suitable shunts, can be used as a milliammeter too. It is 2" in diameter and designed for panel mounting. Bakelite base and black-enamelled cover. Shp. Wt. 2 lbs.



ITEM NO. 85  
YOUR PRICE ..... \$1.25

## POWERFUL ALL-PURPOSE INDUCTION MOTOR IDEAL FOR EXPERIMENTERS—101 USES

Sturdily constructed to precision standards, this self-starting shaded pole A.C. induction motor is powerful enough for a large variety of uses. Some of these are: Automatic Timing Devices, Current Interrupters, Electric Fans, Electric Chimes, Window Displays, Photo-cell Control Devices, Electric Vibrators, Small Grinders, Buffers and Polishers, Miniature Pumps, Mechanical Models, Sirens, and other applications.

Consumes about 15 watts of power and has a speed of 3,000 r.p.m. When geared down, this sturdy unit will constantly operate an 18-inch turntable loaded with 200 lbs. dead weight—THAT'S POWER!

Dimensions, 3" high by 2" wide by 1 1/4" deep; has 4 convenient mounting studs; shaft is 3/16" diam. and runs in self-aligning oil-retaining bearings. Designed for 110-20 volts, 50-60 cycles, A.C. only.

ITEM NO. 147  
YOUR PRICE ..... \$1.45

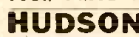

## WESTERN ELECTRIC BREAST MIKE

This is a fine light-weight aircraft carbon microphone. It weighs only 1 lb. Mike comes with breast-plate mounting and has 2-way swiveling adjustment so that it can be adjusted to any desired position. There are 2 woven straps; one goes around neck, the other around chest. Straps can be snapped on and off quickly by an ingenious arrangement.

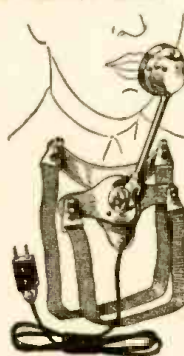

This excellent mike can be adapted for home broadcasting or private communication systems by dismantling breastplate. It can be used as desk mike. Comes complete with 6-foot cord and hard rubber plug. Finished in sherardized plate, non-rustable.

THIS IS A BRAND NEW MIKE. IT HAS NEVER BEEN SOLD AT SUCH A LOW PRICE BEFORE. ORIGINAL LIST PRICE \$15.00. Shipping weight, 2 lbs.

ITEM NO. 122  
YOUR PRICE ..... \$2.55

## METAL CUTTING SAW

Here is an ideal metal-cutting saw made of fine tool steel specially designed to cut metal. Teeth are set at a special double angle for metal-cutting work. Saw is specially hardened for long and extended use; measures 3 1/4" diameter; center hole is 1/2" square; thickness 42/1000 (42 mils.) 3/64".



ITEM NO. 151  
YOUR PRICE ..... 50c

## POWER ADJUSTABLE RHEOSTAT

Here is an excellent rheostat used especially to regulate speeds of small motors, such as our Handy Workshop Outfit. This rheostat can be used in connection with motors up to 1/20 h.p.



This fine rheostat is wire-wound on porcelain insulation. The black enamel steel casing is perforated for ventilation. Adjustable handle rescales speed of motor easily and smoothly. Size 5"x2 3/4" overall. Shp. Wt. 2 lbs.

ITEM NO. 153  
YOUR PRICE ..... \$1.45

## AMAZING BLACK LIGHT!!!

Powerful 250-Watt Ultra-Violet Source



The best and most practical source of ultra-violet light for general experimental and entertainment use. Makes all fluorescent substances brilliantly luminescent. No transformers of any kind needed. Fits any standard lamp socket. Made with special filter glass permitting only ultra-violet rays to come through. Brings out beautiful opalescent hues in various types of materials. Swell for amateur parties, plays, etc., to obtain unique lighting effects. Bulb only. Shp. Wt. 1 lb.

ITEM NO. 87  
YOUR PRICE ..... \$2.00

## WATT HOUR METER

Completely overhauled and ready for immediate service. Designed for regular 110-volt 60 cycle 2-wire A.C. circuit. Servicemen use it in their shops to check current consumption of sets, soldering irons, etc. Keeps costs down. If dismantled, the parts alone would bring the price. The elaborate gear train could be used as a counter on machines of various kinds. Simple to install; 2 wires from the line and 2 wires to the load. Sturdily constructed in heavy metal case. Size: 4 1/2" high, 3 1/2" wide, 5" deep. Westinghouse or General Electric. Shp. Wt. 14 lbs.



ITEM NO. 33  
YOUR PRICE ..... \$4.95

## HUDSON SPECIALTIES CO., 40 West Broadway, N. Y. C.

IT'S EASY TO ORDER—CLIP COUPON—MAIL NOW ORDER FROM THIS PAGE.

HUDSON SPECIALTIES CO., 40 West Broadway, Dept. RC-1-43, New York, N. Y.  
I have circled below the numbers of the items I'm ordering. My full remittance of \$..... (include shipping charges) is enclosed.  
OR my deposit of \$..... is enclosed (20% required), ship order C.O.D. for balance. No C.O.D. order for less than \$2.00. (New U. S. stamps, check or money order accepted.)  
Circle Item No. wanted: 11, 33, 35, 87, 147, 151, 152, 153, 154

Name ..... Address .....  
Please Print Clearly  
City ..... State .....  
Send remittance by check, stamps or money order; register letter if you send cash or stamps.

## SERVICING A.C.-D.C. MIDGETS FOR BEGINNERS

(Continued from page 234)

often have sufficient leakage to mask the effect of an open resistor. While making this test, check the leakage resistance of the bypass condenser with the ohmmeter.

Circuit disturbance tests on these receivers are limited to touching the control-grid caps with the finger or removing the caps, for pulling out a tube opens all filament circuits and masks the effect of the test. The above tests should result in location of the trouble in any "dead" universal-type receiver which uses a conventional T.R.F. circuit.

## ADDITIONAL DATA

*Servicing Weak Receivers.* Essentially the same tests are made on a weak receiver as on a dead receiver. In addition, the dynamic loudspeaker field coil and its supply should be checked by applying a screwdriver to a pole piece; absence of pull indicates a defective field coil or no supply voltage to it.

The continuity of the aerial should be checked with an ohmmeter, and the trimmer condensers should be readjusted for maximum output. Weak reception can often be cured by moving the control-grid leads around enough to secure a small amount of regeneration.

It is a good idea to check the line voltage in the customer's home when weak reception is the complaint; if this voltage is below normal, report the matter to the local power company.

Ordinarily there is nothing you can do to a receiver of this type to offset low line voltage. Excessively high line voltage is not serious in these small receivers, for the tube filaments and the pilot lamps are designed to stand up under all normal fluctuations in line voltage.

With D.C. power lines particularly, the line voltage on peak loads may drop to a point where no reception is obtained, and again the trouble is not the fault of the receiver.

*Servicing Receivers for Hum.* A certain amount of hum is to be expected in any receiver operating from an A.C. line. Many service men forget this fundamental fact and spend hours trying to eliminate perfectly normal hum which they observe after correcting the original defect in the receiver. Hum should never be so loud, however, that it becomes annoying when listening to the program from a local station. Excessive hum is often caused by a reduction in capacity of filter condensers, by a heater-to-cathode short in some tube, by an improper connection of a filter condenser, or by an open control-grid return.

*Curing Distortion.* Improper centering of the loudspeaker voice coil is a common cause of distortion; the usual corrective methods apply here just as in larger receivers. Always try a new output tube when distortion is the complaint, for the great amount of heat dissipated by the heater in this tube often affects other electrodes in the tube.

A leaky coupling condenser between the detector and the grid of the output tube is another likely cause of distortion. If you can measure a D.C. voltage across the grid resistor of the output tube when the positive voltmeter probe is connected to the grid end of this resistor, a leaky coupling condenser is indicated; replace with a 0.05-mf., 600-volt cartridge condenser if you cannot determine the value of the original part. Check the ohms values of the cathode bias resistors, and check cathode bypass con-

(Continued on page 249)



## CONSTRUCTING THE "SIMPLICITY—1"

(Continued from page 222)

kept down. Therefore it had to be wound into very small space and placed at the ground end of the tuning coil, where its capacity effect would be at minimum.

Placement is rather critical. Once the best position is found the coil should be locked in place with a drop of cement.

In our case the tickler leads were enclosed in a piece of flexible sleeving and brought back through the coil.

The tickler coil itself was made by cutting out two little discs of thin cardboard. The diameter was such that it would just

go into the tube of the "Capind." A round toothpick was used as a form and the two discs were mounted on it three-quarters of an inch apart to make end pieces. Then the toothpick was put in the hand-drill and 600 turns of No. 38 wire were wound on it. (Had I built myself a cylindrical form, say of diameter not much smaller than the inner diameter of the tube, the chances are that fewer turns would have sufficed.)

The turns close to the toothpick are very small and have little inductance.

The coil was placed inside the ground end of the "Capind" tube in a position where it just cleared the wound part.

A socket seemed just another luxury in wartime. Therefore the leads were soldered

directly to the tube prongs.

The switch was made of a small piece of curtain rod and part of a tin can. The writer was afterward shown how a much simpler switch which can be made from a paperclip and a pair of screws—as illustrated in Figure 3.

The case was larger than originally intended. The first idea was to build it around a battery of 40 to 60 flashlight cells. Large-size portable batteries were still available at the time of construction, so they were used in spite of the somewhat greater size of the set.

It is our intention, however, to bring out an "Advanced Simplicity Receiver" shortly. This will dispense with practically all standard radio components except the tube. Condensers and resistors will be home-constructed, and the user will be able to choose battery operation, using "pen-lite" cells, or electric operation.

A certain amount of caution is necessary in tuning. Those experimenters who are not familiar with one-tube regenerators will be well advised to push the throttle condenser pretty well in, then slowly move the "Capind" in and out till a station is heard.

Then the throttle condenser can be pulled slowly out till the signal strength comes up to a maximum. The opposite method—pulling the throttle all the way out—will produce a series of whistles which make it difficult to tell anything about the stations you are tuning across.

In addition, if you are using an outside aerial you will produce the same kind of howls and whistles in the sets of all your neighbors. The days of "blooping" are over, and any radioist who creates interference in a neighbor's receiver should be prosecuted for operating an interfering transmitter!

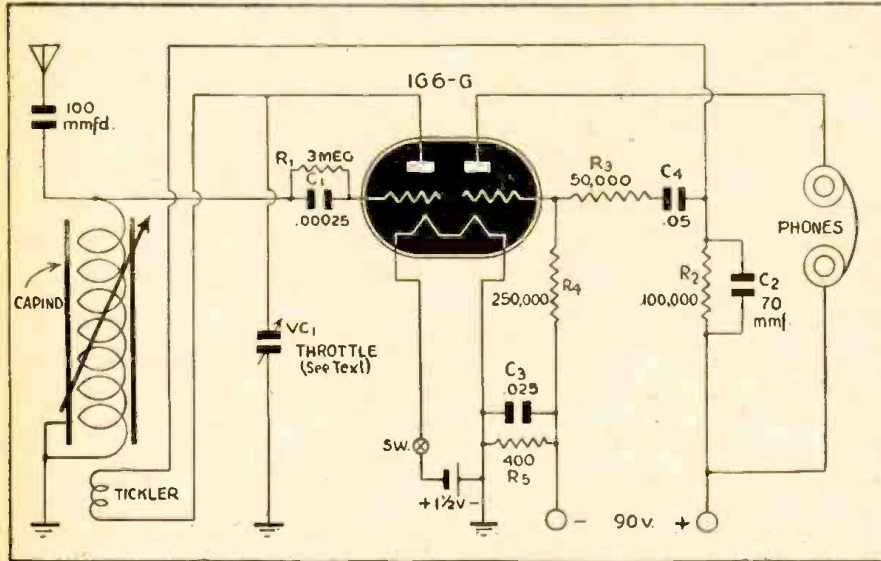

Schematic of the Simplicity—1

## A SIMPLIFIED ELECTRONIC VOLTMETER

(Continued from page 210)

ing the contact stick as the set is turned over and back during alignment, a metal cap or a coil of wire can be slipped over the output tube and the meter connected to this. Enough capacity pickup will be realized to make the meter read without otherwise contacting the audio system.

The meter may be used as a signal tracer in the audio system. When signals are weak, the one megohm isolating resistor can be removed. This upsets the calibration, of course, but as comparative measurements only are used in signal tracing true calibration is of no advantage.

### MEASURING GAIN

To measure the actual gain of a stage or coupling device, divide the reading at the output by that obtained at the input without varying the volume setting. Example, if the input reading is 3 and the output 9, the gain is 9 divided by 3, or 3.

To measure excitation or driving voltages, it is necessary to multiply the meter reading by 1.41 which will give the peak voltage. (The electronic meter reads average voltages). Likewise, to determine if an amplifier is being overloaded the signal voltage at the grid can be measured and multiplied by 1.41 and the results compared to the bias being used on the tube. In Class A circuits, the signal voltage at the grid should not exceed a value equal to the bias of that particular stage. The value of signal voltage for other classes of amplifiers can usually be found in the tube manual.

In signal tracing through coupling devices it is well to know that a loss in signal is

usually experienced across driver transformers and very little gain is obtained in Class B amplifiers.

### CHECKING COMPONENTS

Regardless of what system of radio servicing is used, the ultimate object is to locate the defective part. Any device that will locate such parts, (particularly without removal from the circuit) is indeed an asset. The electronic meter is such a device.

### LOCATING FILTER TROUBLE

Locating filter trouble is no particularly difficult job for the service man, but locating the particular filter often necessitates removal of two or more parts from the circuit before the bad one is located.

With the electronic meter, A.C. ripple present at the filters can be measured, and this is a direct indication of the filtering action of the condenser. The amount of A.C. ripple at the first condenser varies from approximately 25 volts with about an 8 mfd. condenser, or 8 or 10 volts with a 24 mfd. If the set has only two filter condensers, the ripple should be decreased so that it does not exceed one or two volts at the output. When more than two filter condensers are used, the decrease is divided between the two.

To locate a shorted or leaking condenser it is only necessary to make D.C. voltage measurements across the condensers. A big drop from one condenser to the next indicates that the one with the less voltage is the defective part.

If the condensers have a common positive the procedure is the same, but the negative probe has to be moved to the negative side of each condenser to make the proper measurement.

### BYPASS CONDENSERS

Bypass condensers are in a circuit for just that purpose. While this particular meter cannot be used to check the bypassing action of R.F. condensers without an R.F. amplifier, it can be used to check bias condensers and audio bypasses.

If a cathode bypass is open it can be detected in two ways; the bias will go up as will the audio signal drop across the bias resistor.

The first can be checked by measuring the D.C. voltage across the resistor; and the second by measuring the audio component with the D.C. blocked out with a condenser in series with the probe.

If the condenser is shorted or leaking, the opposite occurs. The bias will decrease due to the parallel resistance across the bias resistor. The audio signal will decrease if the leakage is great, but may increase if the condenser capacity is shorted but its D.C. resistance is high.

To check for leaky and shorted bypass condensers, measure the D.C. across the resistor that is being bypassed. If a screen grid bypass, remove the tube which removes the current drain through the grid resistor.

The voltage should be the same on both sides of the resistor if the bypass is not leaking. Accordingly, plate bypass condensers can be checked by measuring the voltage across the plate resistors and transformers.

### CURRENT MEASUREMENTS

While the instrument is not a current-  
(Continued on page 248)



*Become a Charter Member  
of Our Growing Family —*

# Look Ahead America!



## Look to the Sky for the Shape of Things to Come

A new thrill for Radio-Craft readers . . . up-to-the-minute, yes, real newsy fine stories and instructions. The perfect 3 point landing . . . flying . . . model building . . . news. Get all three in every issue of

# AIR-AGE

(The new aviation magazine)

Many large 8½ x 11¼" pages are crammed with actual photographic pictures of scoops that will excite you . . . articles by leading authors on aviation tell you just what you want to know.

On sale now at all newsstands or  
Charter subscriptions  
**ONE FULL YEAR 75¢**

SILCO PUBLISHING CORP., Dept. R  
160 West Broadway, New York  
Send me AIR-AGE for one full year at the special charter subscription price of 75¢. I enclose 75¢ (Cash or Money Order) in full payment.

Name . . . . .  
Address . . . . .

## A SIMPLE TRANSRECEIVER

It has been the belief that "transceivers," even at very high frequencies, are merely make-shift affairs to serve only as substitutes for bona fide transmitting and receiving equipment. Therefore, I feel that any sizable investment should be concentrated

that requires an absolute minimum of space and parts, and still compares favorably with its more elaborate counter parts. High performance, even at 1¼ meters is made possible by the use of the inexpensive RCA 9002 UHF tube.

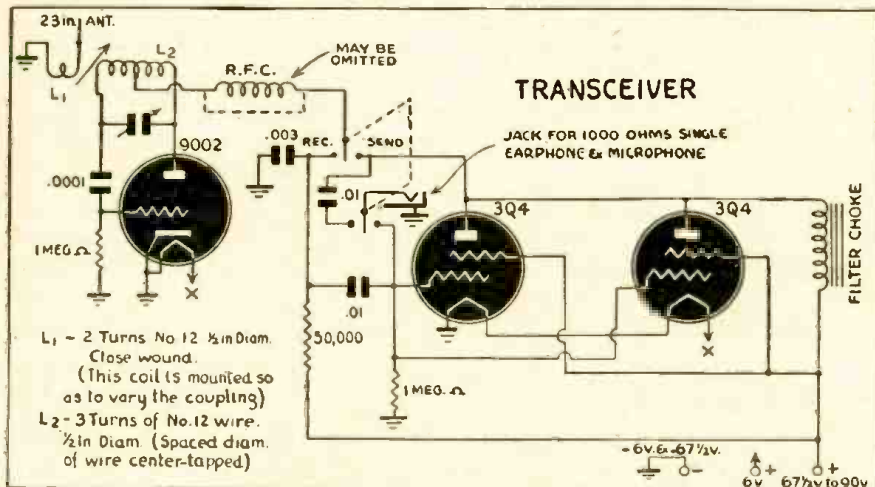

in a transmitter-receiver combination rather than an elaborate transceiver.

However, I am aware of the desirability of compact, lightweight gear of this type for short range portable work. With all this in mind, I have designed a transceiver

This outfit makes a fine emergency WERS receiver or transmitter. The diagram is shown above.

JAMES D. ALEXANDER,  
Terre Haute, Ind.

## SENSITIVE P.-E. CELL AMPLIFIER

Following is a diagram of a circuit which was converted by me for use with the 117L7GT tube.

In this circuit one tube does the work of two 37's and has much higher amplification. There is no need for a voltage-dropping

line cord resistor. All this makes possible a more compact and efficient unit.

This circuit has sufficient power to work

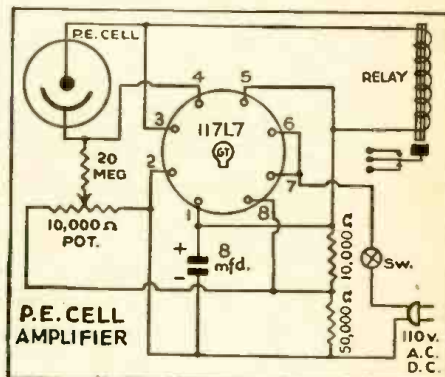

home-made relays. Strong sensitive relays can be made from old telephone ringers or cheap high-resistance milliammeters.

EUGENE HARMON,  
Pittsford, N. Y.

## A DIFFERENT TONE CONTROL

This tone control circuit is one of the simplest and most "bug-proof" I have ever used. The condenser should be one of good quality. The 50,000 ohm resistor need be no larger than ¼ watt. The potentiometer should be a noiseless carbon. Any size potentiometer between 250M and 1 Meg. will do, with 500M ohms recommended.

The .006 mfd. condenser is connected from the outer leg of the 50,000-ohm resistor to the center arm of the potentiometer. When

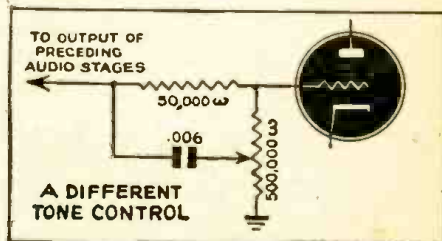

the arm is at the ground side of the "pot" the highs are by-passed, giving bass reproduction. When the arm is at the grid side of the "pot" the bass is attenuated due to the R/C pad (the .006 mfd. condenser offers higher resistance to the bass notes than it does to the high notes), and the reproduction is treble.

Intermediate positions of the arm will give different bass-treble response. Best position is determined by the listener's ear.

LEON A. WORTMAN,  
Brooklyn, N. Y.

## BREAK FOR REPAIR MEN

According to a recent announcement radio repair men whose service charges have been based upon the prices of competitors, may raise their prices if permission to raise these prices has been granted their competitors by the OPA.

There have been numerous complaints from radio repairmen and other service experts that OPA has allowed their competitors to charge better prices for jobs than they.

The new amendment to the services regulation is designed to eliminate this inequality.

Something like this has been needed for quite some time and it will no doubt help matters considerably, especially when dealing with customers who want to argue about costs.



**HANDY LIGHT**

While working in dark corners of a radio chassis, I wore out my flashlight cells.

I tried an old output transformer from an A.C.-D.C. set as a step-down transformer to supply "juice" for the 2.5 volt flashlight. It worked so well that I decided to write and tell you about it.

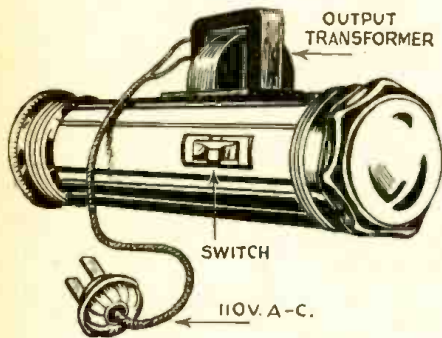

The transformer is so light it may be mounted right on the flashlight.

The voltage on the primary is 110 V., A.C.

WM. J. CHERMAK, Hopkins, Minn.

**CONVERTIBLE FLASHLIGHT**

To convert flashlight into handy test light, drill a small hole in the back of light

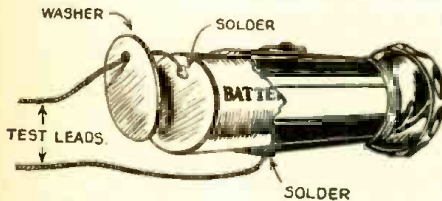

case, and cut an insulating washer to fit on bottom of back battery.

Drill hole in washer to put test wire through, then solder one test wire to bottom of back battery. Run wire through washer and out through back of flashlight.

Solder the other test lead to shell of light. Ground the lead that is soldered to back of case and you can use as a regular flashlight.

RAY ATTWOOD, New Edinburgh, Ark.

**DESK MIKE**

This kink will be of interest to all radio amateurs and fans. It concerns an absolutely original get-up for a microphone.

The accompanying pictures will make the arrangement of the separate parts clear.

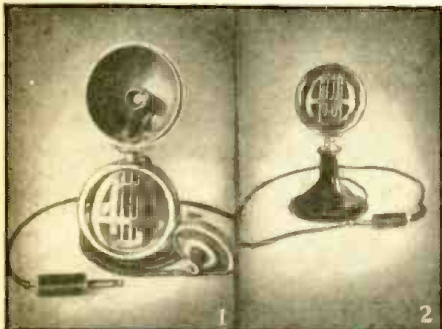

First, get a small fender or tail light case from an auto supply store or a "junkie". Most garages have many of these from wrecked cars and will probably give you one either free or at a nominal charge.

Solder your carbon mike button to the part of the light socket that plugs into the light case. Then all you need do is to cut off the spoon part of a large heating spoon from your own kitchen, and put that into the frame that fits on the light case, and that makes a very commercial looking grille for your mike, (See Fig. 2).

Lastly, find the base from an old electric fan and fit that to the bottom of your automobile fender light, and the mike is complete.

As can be seen from the picture, Fig. 1, the carbon button can then be plugged in or out of the light case with just a turn of the wrist, and the button is held in place firmly by the spring in the light socket.

The whole assembly makes a first-class, very neat and commercial looking, and very solid mike stand.

Those who do not have the funds to purchase an expensive mike stand will find this kink very useful.

It is the most attractive and original stand that I have seen.

ROBERT W. L. MARK, Hawley, Pa.

**DRY AND WET "A" CELL ADAPTER**

Some of my customers with two-volt farm radios like to use dry "A" batteries on their sets while they have the storage cells recharged, keeping their set in playing

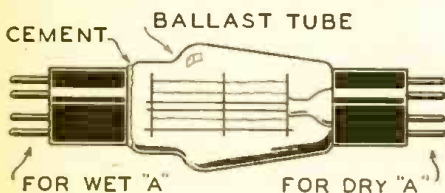

Practically all such sets have provision for a ballast tube on the chassis, usually with a shorted plug. I use an old tube base from an '80 tube, short the proper prongs, and cement this to the TOP of the correct ballast tube. Labelling both ends plainly as to which end to insert for wet or dry "A" battery completes the job.

I make the same provision on sets now using dry batteries, so that they can use either type at will. It makes for a satisfied customer.

C. W. KUNKELMAN, Cambridge, Idaho

(Continued on page 250)

order all the time. I solve this problem in the following manner:

**PROTECTING THE VOICE AND EARS OF OUR FIGHTING FORCES**

Lives—Victories—depend on the proper performance of the radio equipment which is the voice and ears of our fighting forces. Army and Navy technicians depend on the same accuracy, dependability and ease of operation which have made the name Supreme famous for over 14 years.

Supreme Radio Testing Instruments keep communications open.

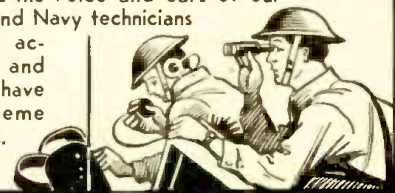

**SUPREME** GREENWOOD, MISSISSIPPI U. S. A.  
TESTING INSTRUMENTS

**NEW CATALOG**

OF SOUND AMPLIFYING SYSTEMS  
AUDIOGRAPH Sound Systems represent the latest in Public Address equipment—a complete line plus pre-tested accessories.

**NEW LOWER PRICES**

Outstanding quality and performance at prices that help you meet any competition.

WRITE FOR YOUR FREE COPY

**AUDIOGRAPH**  
THE FIRST NAME IN SOUND

John Mack Industries—Liberty of Pennsylvania Ave., Plymouth, Ind.

**If It's a CANNON-BALL**

It is a **GOOD HEADSET**



For clarity of tone use Cannon-Ball sensitive phones. Assure dependable performance. Guaranteed to give absolute satisfaction. Write Headset Headquarters for folder C-1 illustrating complete line.

Scientifically built Heavy bar magnets greatly increase their efficiency.

C. F. CANNON COMPANY  
SPRINGWATER, N. Y.

**LEARN RADIO**

**TELEVISION**

600 LICENSED graduates placed in past 7 years in shipping, broadcasting, aviation, police, etc.; we also teach radio servicing and repairing; new beginners' class now forming; 60-page catalog free; oldest, largest and best equipped.

**MASS. RADIO SCHOOL**

18 BOYLSTON ST., BOSTON, MASS., Est. 1899

**Inventions Wanted**  
Patented or Unpatented

We have been successfully selling inventions, patented and unpatented, since 1924. Write us, if you have a practical, useful idea for sale.

CHARTERED INSTITUTE  
of AMERICAN INVENTORS

Dept. 109 Barrister Building, Washington, D.C.

**PATENTS — TRADE MARKS**

Booklet concerning Inventions & Patents Form "Evidence of Conception" with instructions for use and "Schedule of Government and Attorneys Fees"—Free  
**LANCASTER, ALLWINE & ROMMEL**  
Registered Patent Attorneys  
436 Bowen Bldg. Washington, D. C.



# HOW TO MAKE A GOOD ANTENNA

By FRANKLIN WILLIAMS, W6ULE

A GOOD antenna system should be:  
 1. Durable—strong enough to withstand a heavy wind.

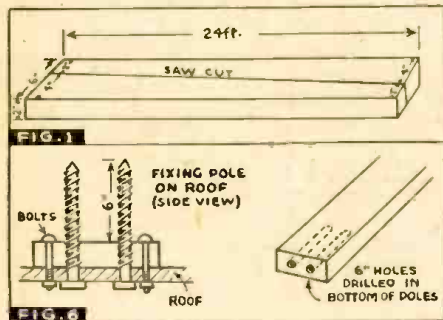

2. Economical—should cost under \$5.
3. High—at least 30 feet off the ground.
4. Versatile—in a position where it is easy to take down the antenna wire.
5. Easy to install.

The antenna described here has been in use for over a year, with great success.

It was decided to mount two short poles on top of the house and garage. Each pole is 24' long and the roof where they are mounted is high enough to bring the total height to over 35 feet.

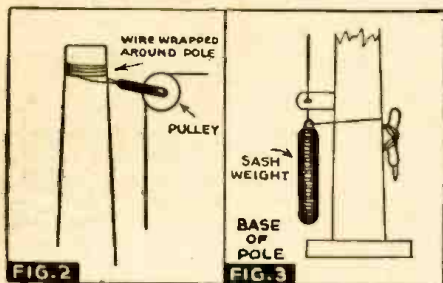

The poles are cut from a single piece of wood, 24' by 2" by 6" (See Fig 1.). Have this piece of wood cut diagonally at the lumber yard so that you will have two poles, 2" by 4" at the base and 2" by 2" at the top. This taper is somewhat lop-sided but this makes very little difference in the strength of the poles.

Each pole is planed, sandpapered with coarse sandpaper, given two coats of white house paint, and one of spar varnish. If you prefer the poles less conspicuous, paint them with green paint instead of the white.

The clothes-line rope supporting the antenna wire runs over pulleys at both ends and is kept taut by a ten-pound sashweight at one end, the other end being tied at the base of the pole (See Figs. 2, 3 and 4.).

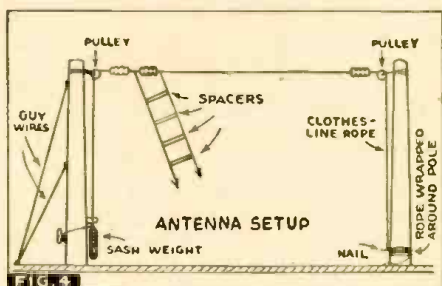

Six guy wires are used at each pole, two at the top and three half-way down (See Fig. 5.). The sixth is a safety guy and is run from the half-way point on the pole toward the other pole so that the pole will not fall over backwards in case the antenna wire snaps. No turnbuckles or guy insulators were used on the guy wires although it is better to use them. Retighten the guy wires every six months or so.

Fig. 6 shows base of pole is mounted on roof.

If the antenna is to be used for receiving

purposes exclusively, a doublet is best, perhaps. This consists of a wire broken in the middle by an insulator with a twisted pair of wires going to it. The antenna will be

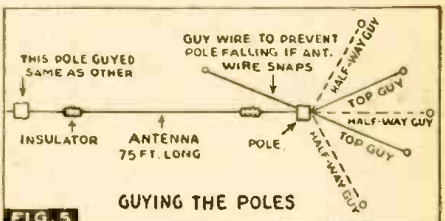

most efficient when the frequency being received is equal to the resonant frequency of the antenna. A length of about 76' is about right for general short-wave purposes. If you do not want to go to the trouble of erecting a doublet, a single wire will serve almost as well.

When using this antenna as a 1/2-wave end-fed Zepp on forty meters (See Fig. 7.), signals from every part of the world were received with good signal strength on a low-priced communications receiver.

As a transmitting antenna at W6ULE, the results were excellent. From here in California, with only a few watts on forty

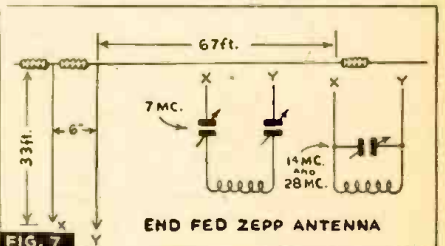

meters, code contacts were quite consistent with the entire United States.

## A TINY P.A. AMPLIFIER

It is seldom that we run across miniature amplifiers, especially one designed for public address work, which will fit in the average man's overcoat pocket. For that reason, a unit like this is of unusual interest, and more so when we consider its design features.

In dimensions, it measures only 4 x 7 x 2 3/4 inches, yet on this small chassis we find all components and tubes necessary to amplify the feeble output of either crystal microphone or phonograph pickup to a full output of over 2 watts!

This output is more than sufficient to

drive any good 6 or 8 inch permanent-magnet dynamic loudspeaker, so that it will fill a decent-sized auditorium or home with a good quality of music or speech. To those who are not convinced, we wish to add that engineers estimate that 2 watts of audio output should be uncomfortably loud in a home.

The output of 2 watts, at least, is assured by the use of a 25L6 beam power, output tube. (See Fig. 1.) Sufficient voltage gain to drive this beam tube is obtained through the use of a 6J7 tube used as a voltage amplifier.

The 25Z6 functions as a rectifier on both 110 volts A.C. and D.C. Since the types mentioned are all of the "all-metal" tube variety, it can be readily understood why the amplifier may be made so compact, since metal tubes are physically much smaller than equivalent glass types.

Concerning the layout and construction of this amplifier, little can be said about the best procedure, inasmuch as its compactness calls for crowded assembly and a certain nimbleness with the soldering-iron. However, it is reasonably possible for the average constructor to duplicate this unit. Since it is desirable to minimize hum pick-up and avoid possibility of audio feedback, it is recommended that all "live" audio (plate and grid) leads that are over 2 inches in length be incased in metal sheathing. Shielding of these leads is sufficient to reduce such detrimental factors.

The operation of the unit is very simple, since the power switch is ganged to the volume control. The input connections, it will be noted, are made directly to the grid of the 6J7 tube, and hence is of high impedance. Consequently, only high-impedance pick-ups or microphones should be connected to this source.

In other cases a suitable matching transformer is obviously necessary.

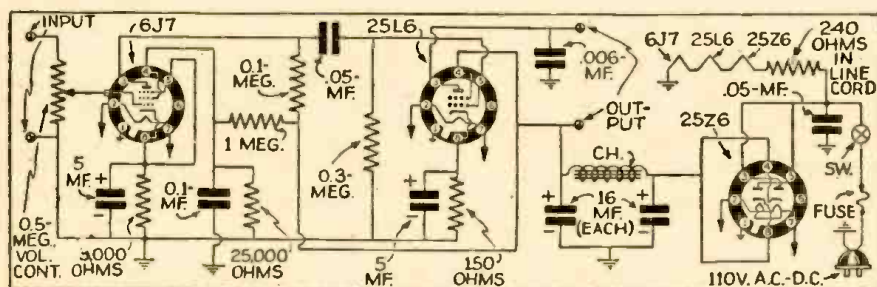

A simple good quality amplifier using 25L6. Anyone can build this who wants about 1 to 2 watts of output.



**RADIOS IN 86% OF HOMES**

**A** BREAKDOWN of the 1940 Census of Housing by the bureau of census of the Department of Commerce reveals that 86.8% of the 30,721,944 white households of the nation have radios.

Only 43.3% of the 3,168,562 non-white households (mostly Negro) have radios.

Ownership of radios among the non-whites was greatest in the states where the Negro population is concentrated in the cities, and lowest in those states where the non-white population is in rural areas.

**NEW JERSEY HAS MOST RADIOS**

Following is a state-by-state summary of radio ownership from the Second Population series of the 1940 census:

State	White Households with radio		Non-White Households with radio	
	No.	Pct.	No.	Pct.
U. S.	26,674,737	86.8	1,373,482	43.3
Ala.	271,869	63.7	49,802	22.2
Ariz.	84,125	75.4	3,656	23.3
Ark.	219,531	61.3	25,055	20.4
Calif.	1,872,907	93.5	60,121	79.0
Colo.	254,707	84.7	3,866	77.1
Conn.	409,987	95.8	7,272	89.0
Del.	54,966	91.1	4,955	58.1
D. C.	127,067	97.4	31,310	80.9
Fla.	287,062	77.0	39,385	30.0
Ga.	329,994	69.0	51,674	20.7
Idaho	118,106	86.7	718	53.0
Ill.	1,888,875	92.7	85,729	83.7
Ind.	800,127	88.5	26,477	80.9
Iowa	613,028	90.3	3,978	79.7
Kans.	398,694	83.5	13,290	72.0
Ky.	414,852	66.7	29,564	57.0
La.	254,192	69.0	53,691	25.6
Maine	183,767	86.5	581	76.4
Md.	354,313	92.0	42,025	65.0
Mass.	1,030,390	96.3	14,440	86.8
Mich.	1,228,287	93.6	43,212	88.0
Minn.	643,064	91.3	4,435	75.6
Miss.	164,763	63.4	40,850	16.0
Mo.	787,530	80.7	45,060	67.2
Mont.	132,437	87.1	2,066	51.7
Nebr.	295,047	84.8	3,743	77.4
Nevada	25,609	83.4	591	39.8
N. H.	116,636	90.0	173	82.4
N. J.	978,513	96.4	41,953	78.9
N. M.	65,255	55.8	1,354	16.5
N. Y.	3,252,442	95.7	133,178	92.0
N. C.	407,854	71.8	64,009	32.7
N. D.	130,003	89.0	997	48.6
Ohio	1,627,678	92.2	69,994	81.3
Okla.	386,266	71.9	19,488	37.2
Ore.	288,177	88.8	2,464	71.9
Penn.	2,168,679	92.7	97,242	85.5
R. I.	173,988	95.9	2,751	87.3
S. C.	179,070	72.1	30,472	17.5
S. D.	134,292	86.0	1,757	37.3
Tenn.	384,851	67.6	49,882	39.5
Texas	1,007,582	72.3	82,624	34.9
Utah	125,592	93.0	826	48.3
Vt.	80,106	88.6	147	78.6
Va.	354,544	75.5	55,434	39.2
Wash.	465,750	90.9	6,803	72.1
W. Va.	307,556	75.6	18,791	68.5
Wis.	738,151	91.8	4,927	78.0
Wyo.	56,456	84.8	670	58.5

**FLAW DETECTOR SPEEDS RADIO TUBE PRODUCTION**

**I**NCREASED production of radio tubes for the armed forces, has been made possible by the development of a "thorium" detector that automatically sorts tungsten filaments by spectroscopic analysis, Westinghouse Lamp Division announces.

Government requirements call for the use of pure tungsten wire and thoriated-tungsten wire. If the tubes were made with



**THE ELECTRO-SET**

*Get This Electro-Set*  
**ABSOLUTELY FREE!**

JUST THINK OF IT—you can get absolutely FREE, the static electrical set described below. This ELECTRO-SET is sent to you by the publishers with a one-year subscription to RADIO-CRAFT.

**AN IDEAL PRESENT FOR BOYS and GIRLS**

Here is the ELECTRO-SET. It will throw bright electric sparks up to 1/2 in. long. A lot of fun for all—educational and instructive, too. YET ABSOLUTELY HARMLESS.

**H**ERE is the newest and most simple electrical generator that has ever been devised. By using an entirely new substance, static electricity can now be generated by any child or grown-up. The ELECTRO-SET gives not only strong, bright electric sparks, but you can perform dozens of fascinating experiments with it, such as you have never thought possible before.

The ELECTRO-SET uses no batteries and it is not plugged into the electric light-line. It is completely harmless and cannot hurt you, yet delivers long and tingling electric sparks.

Loads of fun for parties. You can also give your friends a lot of surprises by shocking them with harmless electric shocks produced by the ELECTRO-SET. The operation is simplicity itself and there is nothing else to buy.

**THE OUTFIT COMES QUITE COMPLETE.** Here is how it works:



Raise your friends' hair with the ELECTRO-SET.



The Electric Spider Web—one of the most mysterious electrical effects ever produced—yet completely harmless.

Place the special Electrodyne sheet on any metallic surface such as a pie plate, metal desk, etc. Rub the Electrodyne sheet briskly with the special "RUBBER" that comes with the outfit. Now place the round disc-electrode, with its insulating handle, on top of the Electrodyne sheet. Then when you lift the disc up, it is electrically charged and you can draw long sparks from it. This can be repeated dozens of times without further rubbing, because the powerful Electrodyne sheet will hold the electrical charge for days, and often weeks.

We have shown a few exciting experiments of more than 100 which you can perform with the ELECTRO-SET. You can make your friends' hair stand up. Then you can perform a really marvelous and exciting Salt-storm which actually is a miniature snowstorm.

You can mystify your friends with the Electric Spider Web which gives a remarkable sensation of LIVE SPIDER WEBS tingling all over your face. Then you can demonstrate the Crazy Electric Balls. Did you know that you can SMELL ELECTRICITY? You can—with the ELECTRO-SET. You can HEAR ELECTRICITY with the ELECTRO-SET. You can FEEL ELECTRICITY with the ELECTRO-SET. You can TASTE ELECTRICITY with the ELECTRO-SET.

**T**RICKITY with the ELECTRO-SET too!

There is no end of fun that you can have with your ELECTRO-SET. You can make numerous experiments yourself besides the many listed in the full set of instructions.

**M O S T I M P O R T A N T.** There is positively nothing to wear out with the ELECTRO-SET. With ordinary care the ELECTRO-SET'S parts will last for years.

You do not have to build anything to make all of these experiments, because the ELECTRO-SET comes to you COMPLETE. Within two minutes after you have received it, you are able to perform the experiments shown here, as well as many others listed in the instructions.

Send your subscription to RADIO-CRAFT for One Year (12 issues) and receive absolutely FREE one of these remarkable sets. New subscribers are accepted or you may extend your present subscription another twelve months. Mail your remittance of \$2.00 to the publishers (Canada and foreign \$2.75). You will receive your ELECTRO-SET immediately by return mail.

**RADIO-CRAFT**  
25 W. B'way, N. Y.

RADIO-CRAFT, 25 W. BROADWAY, New York, N. Y.

Gentlemen: Enclosed find my remittance of \$2.00 for which enter my subscription to RADIO-CRAFT for one year (12 issues). Send me immediately FREE and prepaid the ELECTRO-SET (Canada and foreign \$2.75).  
 New Subscriber     Extend Present Subscription  
 Name .....  
 Address .....  
 City ..... State .....  
 (Send remittance by check, money order or unused U. S. Postage Stamps. Register letter if you send cash or stamps.)  
 RC-143

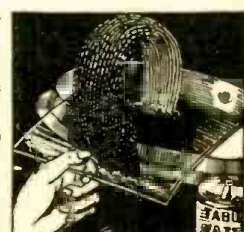

The great Electric Salt-Storm. One of the prettiest experiments to watch. It really is a miniature snowstorm!

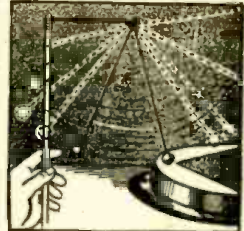

The Crazy Electric Balls. Watch the performance of these erratic and funny balls. They do the most unexpected things.

any other kind of wire they burn out in a short period of time. Introducing a small amount of thorium into the tungsten wire increases electron emission and increases tube efficiency.

The thorium detector, with the aid of a spectroscope—the optical instrument used in observing visible images of the color spectrum—detects the presence of thorium in tungsten wire. The method consists of introducing a sample of pure tungsten or thoriated tungsten wire into an electric carbon arc. As it burns completely, visible results are observed by means of the spectroscope. Two lines appear in the spectrum if the wire is pure tungsten; four appear if it contains any thorium.

**TELEVISION GUIDES PLANES**

**A** NEW invention of Dr. Alfred N. Goldsmith, the well-known radio engineer, will revolutionize plane landings in fog, rain or snow.

The new method eliminates the need for

code and beam directors.

A film, similar to motion picture film, constitutes the central idea of the new device. The films, for several are used, comprise views taken from every possible elevation and angle and each frame is so marked.

The television transmitter is located at one end of the air field and transmits in all directions. An incoming plane picks up the telecast and by charts and calculations the pilot gets his bearings.

At all times he has before him a picture of some sort, but of course all in one line. In other words the plane "sees" only those images that are in its line of sight.

The film is originally made in one of two ways. Either a model of the airport is made, and photographed on lines straight in, from several angles; or a plane is actually flown in on a straight line, and a motion picture taken all the while.

Thus there is a film for each solid angle of approach.

So no matter what line the plane comes in on there is always a set of frames that shows the landing at all times.



# •BEGINNERS•

## OPPORTUNITY AD-LETS

Advertisements in this section cost 15 cents a word for each insertion. Name, address and initials must be included at the above rate. Cash should accompany all classified advertisements unless placed by an accredited advertising agency. No advertisement for less than ten words accepted. Ten percent discount six issues, twenty percent for twelve issues. Objectionable or misleading advertisements not accepted. Advertisements for February, 1943, issue must reach us not later than January 10, 1943.

Radio-Craft • 25 W. B'way • New York, N. Y.

RADIO SERVICEMEN AND EXPERIMENTERS SEND for our latest radio catalogue. Save dollars. United Radio Co., (1000P) Newark, N. J.

OSCILLOSCOPE AND OTHER RADIO PARTS wanted for cash. Send list with prices to John Hart, 1123 Broadway, New York, N. Y.

BECOME A COMMERCIAL BROADCASTING STATION Operator. Complete new course, \$3.00. Institute, 378 Hudson Street, Oakland, Calif.

**USED Correspondence Courses**  
COMPLETE HOME-STUDY COURSES and self-instruction books, slightly used. Sold, rented, exchanged. All subjects. Satisfaction guaranteed. Cash paid for used courses. Full details and 84-page illustrated bargain catalog FREE. Write today! NELSON COMPANY, 500 Sherman, Dept. A-210, Chicago

Quality above all  
**SOLAR CAPACITORS**  
SOLAR CAPACITOR SALES CORP.  
Bayonne, N. J.

**University**  
HIGH EFFICIENCY results in Sound National Defense that is why NATIONAL DEFENSE SOUND SYSTEMS are equipped with University Reflex HIGH POWER LOUDSPEAKERS. UNIVERSITY LABS. 105 CHRISTIE ST., N. Y. C.

## COMMERCIAL RADIO INSTITUTE

A radio training center for over twenty years. Well equipped. Excellent faculty. Practical resident courses in Defense, Radio Telegraphy, Broadcast, Servicing, Industrial, Television, Aeronautical, Drafting, Mathematics and Studio Technique. Placement bureau. Classes now forming. Catalog upon request.  
Dept. D, 38 West Biddle Street, Baltimore, Md.

**LES** Correspondence Courses in **RADIO and ELECTRICAL ENGINEERING**  
**ELECTRICAL ENGINEERING** Get good grasp of wide electrical field. Prepare yourself, at Low Cost, for secure future. Modern, simplified, you can understand quickly.  
**RADIO ENGINEERING** Extra fine course in radio, public address, photo-electric work.  
Trains you to be super-service man, real vacuum tube technician. Exper. kits furnished. Diploma on completion. Tuition, \$25, either course. Deferred payment plan.  
**FREE** Get copies of school catalogs, student magazines, complete details. **SEND NOW!**  
LINCOLN ENGINEERING SCHOOL Box 831-C47, LINCOLN, NEBR

## HOW SIGNALS ARE SENT

(Continued from page 229)

of programs. The short waves are reversing even faster, from 1,500 kilocycles to 60,000 kilocycles.

### WAVELENGTH

We are all familiar with the term *wavelength*. This is only another way to express the *frequency*. If we consider a single impulse of current that is sent out on the aerial of the broadcasting station, we will find that it travels a certain distance before another impulse is emitted. The distance between these impulses or reversals of current is the *wavelength*. This has been expressed in meters instead of the more common feet or yards. A meter is about 39 inches in length.

Radio waves travel at a speed of 186,000 miles per second. Suppose we consider a radio wave of a frequency of 1,000,000 cycles. It takes one millionth of a second before the reversal of current starts. Then the impulse travels at a rate of 186,000 miles per second, for one millionth of a second or about 0.18 miles. This can also be expressed in meters instead of miles and when converted it becomes 299.8 meters.

An easy way to convert frequency to wavelength is to divide the figure in meters into 300,000 to find the frequency in K. C. and divide the frequency in kilocycles into 300,000 to ascertain the wavelength in meters.

### HOW RADIO RADIATIONS ARE PRODUCED

The electromagnetic radiations used in radio work are produced by generating electric currents of the frequency to be used for the transmitter and connecting the source of these high frequency currents to the aerial and ground. The high frequency currents are generated by large vacuum tubes known as "oscillators," which are made on the same principle as the vacuum tubes in our receiver. In fact the receiver can be used to transmit radio waves, if we turn the regeneration control to the right until the set starts to oscillate. Of course, these waves are very feeble and do not travel very far.

Vacuum tubes are used to generate the currents, as it is not practical to make generators of the usual rotating type employed for generating the electric light current, for such high frequencies. Every broadcasting station in the United States is assigned a certain frequency, by the Federal Radio Commission. Practically all stations in one vicinity are assigned different frequencies

or wavelengths, so that we may select the one we want without hearing any of the others. This selection, as we know, is accomplished by tuning the receiver.

The amount of energy picked up in an aerial is extremely small. It is interesting to note that it has been estimated that the amount of energy picked up by the average receiving aerial, coming from a broadcasting station 2000 miles away, if made continuous day and night for thirty years, would about equal the energy expended by a common house fly in climbing up a wall the distance of one inch. The voltage induced in the receiving aerial from a nearby transmitter of average power is in the neighborhood of 50 millionths of a volt—0.00005 volt.

If our eyes were capable of responding to the radiations sent out from the aeriels of broadcasting stations, these aeriels would appear like so many huge lighthouses flashing on and off, each one a different number of times each second, corresponding to the sound vibrations in the program being sent out. Since each station sends radiations of a different frequency, these beams would all appear as lights of different colors to our eyes. Such a sight would be truly fantastic and would enable us to understand more easily how these radio rays travel from the broadcasting station to receiving sets.

## A SIMPLIFIED ELECTRONIC VOLTMETER

(Continued from page 243)

measuring device, it can be used for that purpose very effectively by measuring the voltage drop across a known resistance and in turn substituting this value in the formula.  $I = E/R$ .

For example, to determine the current drain of a 607 through a 100,000 ohm plate resistor, measure the drop across this resistor, (which is usually 100 volts or more). If it is 100 volts, divide this value by 100,000 by pointing off five places to the left and it gives one mil plate current.

The entire D.C. load pulled by a set can be found by measuring the drop across the field or across a choke.

### NOISY TRANSFORMERS AND RESISTORS

Noisy resistors and transformers can be located by connecting the meter across them and watching to see if its movement synchronizes with the scratching noise heard in the speaker.

## REMOTE MIXER

(Continued from page 219)

accomplished by simply plugging the remote control unit into an 8-contact socket on the front panel of the amplifier chassis and turning the corresponding potentiometers situated on the main amplifier to positions marked "R" on dials.

It is important to note however that an amplifier using remote mixing must have 2 input circuits, each using the 1612 tube, which was designed expressly for this purpose.

The schematic circuit of one input channel is shown in Fig. 1.

In Figs. B and C are illustrated both the new and old methods of controlling the input of a public-address system.

The remote control unit is available as a separate unit and is connected to the main amplifier by a cable and plug. This arrangement is shown in section A of Fig. 2.



Are you interested in  
**SOUND MOTION PICTURE PROJECTION?**

**SUBSCRIBE** to **INTERNATIONAL PROJECTIONIST**, the only magazine published that is devoted exclusively to the mechanical and electrical principles of professional sound motion picture projection. It deals with the arc lamp, film projector, sound track, photoelectric cell, sound amplifier, maintenance and repair of projection equipment, and with every detail of high-calibre, professional motion picture projection. I. P. has the endorsement of leading projection supervisors of the United States and Canada.

INTERNATIONAL PROJECTIONIST  
19 West 44th St., N. Y. C.

Enter my subscription for

1 year—12 issues—\$2  
 2 years—24 issues—\$3  
(Foreign—50c per year extra)

Name .....

Address .....



**A VERSATILE SQUARE WAVE AND PULSE GENERATOR**

(Continued from page 207)

is perfect square wave generation.

The next tube is a 7C7 (or equivalent in the 6-volt or 2.5 volt series of tubes, 6J7, 6SJ7, 57, 24, 36, etc.,) and is used as a clipper tube (the tube being operated so as to cause plate saturation). There is nothing complicated in this circuit, except that resistance values must be adhered to for proper results.

The last tube is a cathode follower—meaning actually a tube that permits low impedance output without reflecting the load connected to this output, into the previous stage. This is not a critical circuit, but it is important. The reasons follow:

If we terminate directly from the plate of the 7C7 into a load, a very peculiar situation will occur—namely, the output wave form will be affected, that is it will be distorted due to stray x distributed input capacities and impedances. To prevent this form of distortion the 7C5 (or any other beam power tube) is used to isolate the sensitive plate circuit of the 7C7 tube.

By terminating the plate circuit of the 7C7 tube into a high resistance, such as the grid of the 7C5, and the grid resistor 20 megohms, a *minimum load* is reflected into the 7C7 plate circuit, actually too small to be of any consequence at the given ranges.

The output is taken from the arm of R10, a variable control, large enough in wattage to dissipate the total plate current of the 7C5, through a large capacitor. By thus terminating, the output can be fed into almost any load and controlled from maximum to minimum without disturbing the previous circuit constants.

**CONSTRUCTION HINTS**

Chassis layout and wiring are not too critical, as can be seen in the photos. Of course wiring should be kept to a minimum. Excess wiring and wide spacing will introduce excess distributed capacity, which may be harmful in the final outcome.

**CALIBRATION**

To calibrate the frequencies a variable audio-generator of known values is made to "Zero Beat" against the square-wave-generator frequency by using an oscilloscope and feeding one source into the vertical and the other source into the horizontal deflecting circuits.

When the two frequencies are one single picture as shown in the figures, they "Zero Beat," and all one has to do is to note the audio generator frequency and mark the dial on the square wave generator correspondingly.

By doing this on a number of points the entire band can be calibrated.

Information on how to operate the pulse with control, will be given in the next article.

**OPTICS AND ELECTRONICS**

(Continued from page 218)

lockout allows only a single impulse to be made by the timing circuit, thus converting the welder into a spot-welding machine. Operating at high speed, the quick action of the lockout permits speedy spot welding, and synchronous timing control without any moving parts. Production is thus increased and the reliability and smooth periodicity of the welder permits welding of materials which could not be performed by any other method.

These welders represent the most outstanding industrial application of electronic control in the power field at the present time.

**LEARN! . . .**

**CODE**

By copying code with an

*Echophone*

**COMMUNICATIONS RECEIVER**



MODEL EC-2

Here's the new and improved version of this popular set. Now with an external speaker (just like EC-3). Automatic noise limiter, preselection on all bands, calibrated bandspread, AC-DC safety headphone jack, 8 tubes, \$50 Ke to \$0.5 Mc. Bigger value than ever at only \$42.50, complete with speaker in matching cabinet.

**THEORY**

From These Radio Books, For The BEGINNER to the ENGINEER

FUNDAMENTALS OF RADIO	\$5.00
<small>Everitt, Smeby, etc.</small>	
RADIO OPERATING QUESTIONS & ANSWERS	2.50
<small>Nilson &amp; Hornung</small>	
PRACTICAL RADIO COMMUNICATION	5.00
<small>Nilson &amp; Hornung</small>	
RADIO CODE MANUAL	2.00
<small>Nilson</small>	
RADIO ENGINEERING HANDBOOK	5.00
<small>Keith Henny</small>	
RADIO ENGINEERING	5.50
<small>F. E. Terman</small>	
RADIO PHYSICS COURSE	5.00
<small>Ghirardi</small>	
MODERN RADIO SERVICING	5.00
<small>Ghirardi</small>	
A.C. CALCULATION CHARTS	7.50
<small>Lorenzen</small>	
VACUUM TUBE VOLTMETERS	2.00
<small>Rider</small>	
THE CATHODE-RAY TUBE AT WORK	3.00
<small>Rider</small>	
UNDERSTANDING RADIO	2.80
<small>Watson, Welch, Eby</small>	
INDUCTANCE AUTHORITY	2.50
<small>Edward M. Shiepe</small>	

Mail in your order today!

**HARRISON**

RADIO CORPORATION

11 WEST BROADWAY

NEW YORK CITY

**SERVICING A.C.-D.C. MIDGETS FOR BEGINNERS**

(Continued from page 242)

densers for leakage in the manner already described, for these are also possible causes of distortion.

Distortion often occurs when the volume control is turned up too high when tuned to a strong local station; this is a normal condition due to overloading of the receiver stages or of the loud-speaker, and the remedy obviously is for the customer to keep the volume level below the point at which distortion begins.

*Adjusting Oscillation.* A certain amount of oscillation is to be expected in these midget receivers when the volume control is advanced to its maximum setting, for the designers of these sets depend to a certain extent upon regeneration for high gain. Oscillation at low volume control settings can be due to open bypass or filter condensers, as well as to failure to use tube shields if they were originally provided. Shielding of the control-grid leads of the R.F. and detector tubes, if these leads are over-exposed, or changing the positions of these leads are likely cures. Connecting the aerial to an external ground is sometimes effective in eliminating oscillations. Cramping the aerial into a small space will often cause circuit oscillation; keep this

wire stretched out to its extreme length. As a last resort, when oscillation cannot be cured in any other way, detune the trimmer condensers until it ceases.

*Intermittent Reception.* Any of the usual causes of intermittent reception in radio receivers are to be expected in these midgets, but experience has shown that in most cases either a defective type 43 output tube or a defective coupling condenser between this tube and the detector stage will cause intermittent trouble. Try a new output tube first of all, then try a new coupling condenser. If the trouble persists, wiggle each of the tubular condensers in the receiver in turn with your hand in an attempt to make the trouble appear. If this is not successful, resolder all connections in the receiver. If the volume control is noisy in its action, install a new control. Check the aerial with an ohmmeter while bending it slowly back and forth through its entire length, for this will sometimes reveal a break.

*General Suggestions.* Unless you are thoroughly familiar with the socket connections of the tubes used in these midget receivers, always have tube base layouts at hand for ready reference. These layouts are particularly helpful when making point-to-point voltage or resistance tests and when locating various parts in the receiver.

**AUDIO SCALE FOR BLIND**

(Continued from page 218)

tons for uniforms. Blind operators using it are able to package phonograph needles, 25 to 50 to a pack, more rapidly than by counting.

It is also expected to prove useful to sighted persons who have to work in the

dark, as in film plants, or who must concentrate on such operations as filling narrow-mouthed containers to a net weight content.

J. O. Kleber, electronics engineer of the Foundation; H. D. Bennett, president of the Toledo Scale Company; and Lawrence Williams, chief engineer, directed the demonstration. Mr. Kleber pointed out that in England the blind are now 100 percent employed.



# RADIO KINKS.

**The Book that takes Drudgery out of Mathematics**

Only **50c** postpaid

**SOLVES EVERYDAY PROBLEMS — HELPS YOU GET AHEAD IN LIFE**

How many times have you lost money because of a mistake in figuring? Do you know how to figure quickly and correctly? Can you figure discounts, interest rates, taxes and all the other calculations you meet up with in your daily life?

Are you having trouble qualifying for Army or Navy promotion because you're not up on mathematics?

Here is the book that gives you a good background in mathematics; that takes all the irritation and drudgery out of it. You don't need to be scared of mathematics, because here's the subject explained without frills, without useless computations.

Here's the book for men in the armed forces; for business men; technicians and craftsmen, explaining and answering everyday mathematical problems in easy-to-understand words and illustrations.

Yes, it's the key to a simple understanding of mathematics. It's a real home-study course in mathematics for the man who's alert to the importance of mathematics in the world today.

## ELEMENTARY MATHEMATICS

● EASY — SIMPLIFIED — PRACTICAL ●

### CONTENTS OF BOOK

- CHAPTER I. Arithmetic—Addition—Subtraction—Multiplication—Division.
- CHAPTER II. Factoring and Cancellation—Fractions—Decimals—Percentages—Ratio—Proportion.
- CHAPTER III. The Metric System.
- CHAPTER IV. How to Measure Surfaces and Capacity (Geometry).
- CHAPTER V. Powers and Involutions—Roots and Evolution.
- CHAPTER VI. Mathematics for the Manual and Technical Craftsman—Thermometer conversions—Graphs or Curve Plotting—Logarithms—Use of the Slide Rule.
- CHAPTER VII. Special Mathematics for the Radio Technician.
- CHAPTER VIII. Commercial Calculations—Interest—Discounts—Short Cut Arithmetic.
- CHAPTER IX. Weights and Measures—Useful Tables.

ONLY **50c** POSTPAID

Send Stamps, Cash or Money Order.

Send today for your copy of this indispensable book. It can be carried readily to your pocket. (Size 9 1/2 in.)

**TECHNIFAX**

1917 S. State St., RC-143, Chicago, Ill.

## AN EASY WAY TO SOLDER SMALL PARTS

It is easy to solder small, delicate parts without using the entire tip of a soldering iron. Take a short piece of No. 18 bare copper wire. Bend it around the tip of the soldering iron as shown in the drawing. (Fig. 1). Be sure to tin the soldering iron tip well to form a good bond and heat conductor between the tip and the wire. The end of the wire serves as a very tiny soldering

### COPPER WIRE

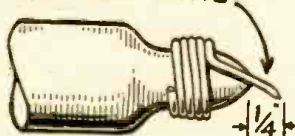

FIG. 1

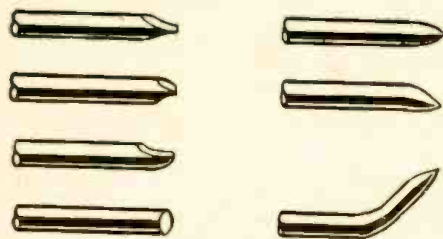

FIG. 2

iron. It heats rapidly due to the fast flow of heat through copper. The wire may be filed to give any type of tip desired (Fig. 2). When larger parts are to be soldered, the full soldering iron tip may be used simply by sliding the copper wire off.

The diagram is shown above.

GARFIELD MILLER,  
Passaic, N. J.

## COIL WINDING

(Continued from page 245)

Radio amateurs and experimenters often find it necessary to wind their own coils. Anyone can get a very professional looking coil by taking advantage of this kink.

Fasten one end of a designated length of

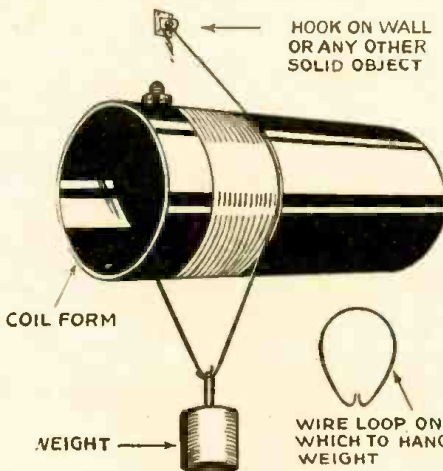

wire to a solid object and the other end to the coil form. Make about two turns and then place the weight and the loop of wire, which is of the same size to be used in the coil, between the turns. And then proceed winding the coil, being sure that the wire is kept tight.

When completed fasten the end of the wire and slip off the loop and weight. You will find that you have made a neat coil and that the turns are evenly spaced.

TONY CALABRESE,  
White Plains, N. Y.

## LEAD-IN ARRANGEMENT

A good way to overcome the drilling of holes in the window or frame is to replace one small light of glass with a weather-proof sheet of material. The writer did this to an upper sash that contained twelve lights of glass.

The light of glass was removed and a piece of Masonite cut to fit the space. This was set with points and putty exactly as glass would be.

Then a suitable hole was drilled for a

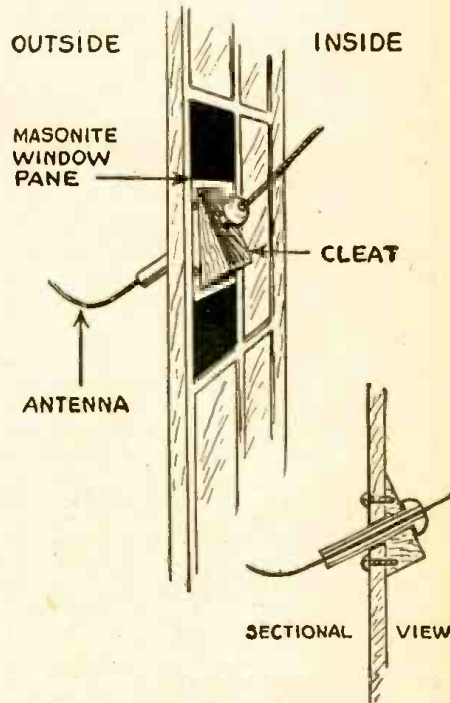

short porcelain insulator. It was held at an upward angle on the inside with a wooden peg. The lead-in wire was then fed through the insulator into the room. The downward pitch prevented rain or snow from driving in from the outside.

This makes a good installation and, in the case of a small window light, does not impair room illumination. The light can be replaced at any time and the window restored to its former condition.

L. B. ROBBINS,  
Harwich, Mass.

## MAKING NEW CARBON GRANULE FOR MIKES

A carbon microphone that has become useless or broken down because of packing of the carbon granules can be renewed and put into use by repacking with new carbon. If the granules are not easily procured you can make your own as follows:

Open a medium grade lead pencil and lay the lead on a smooth surface. Then, with a

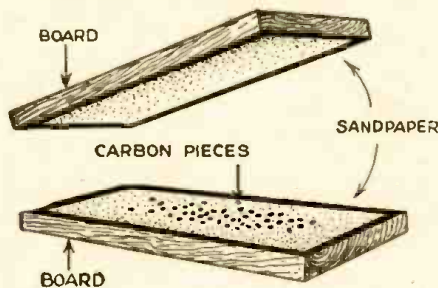

sharp knife or better yet, a fine jewelers saw, cut off sections 1/16 inch long as shown.

Glue pieces of No. 000 sandpaper to two pieces of board. Lay the bits of lead on one papered surface and then roll the other gently over the pieces with the other board, giving the top board a rotary motion as shown.

In a short time the pieces will be reduced to a spherical shape and be rendered into perfect carbon granules for microphone use.

In most cases these will serve as well as the original granules, and in some cases, better.

L. B. ROBBINS,  
Harwich, Mass.

## SOLDERING IRON HOLDER

This soldering iron holder has two principal advantages over other types which I have seen in your columns.

All it consists of is the stator plates from an old variable condenser. The iron should be in the position shown when it is heating.

When it is hot, slide it back so that the tip rests on the plates. The advantages are that (1) the condenser plates will absorb

(Continued on page 253)

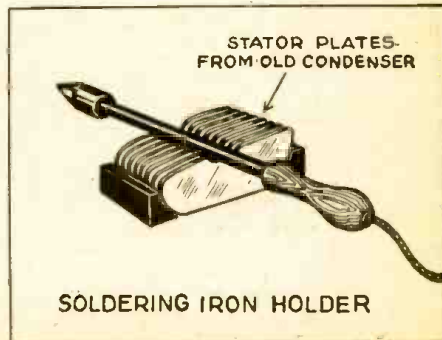

SOLDERING IRON HOLDER



# A New Type of Service Manual!

## RADIO CIRCUIT MANUAL -

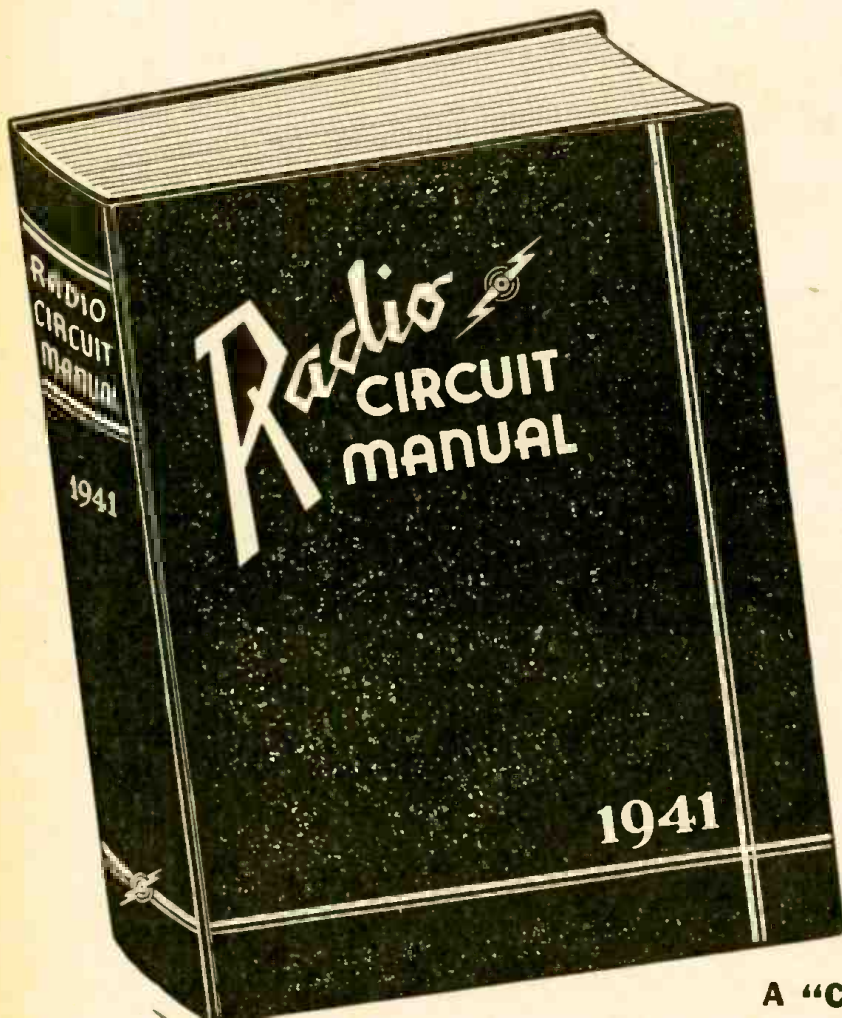

**The Only EDITED Manual  
Ever Published!**

**DIRECTORY OF RECEIVERS MANUFACTURED IN 1940 AND UP TO JUNE, 1941**

**MORE INFORMATION IN HALF THE  
NUMBER OF PAGES**

The value of a service manual is measured not by the number of pages but by the amount of useful information. Thus, in only 736 pages this Radio Circuit Manual covers over 200 receiver models MORE than does any other competitive manual in twice the number of pages.

**HOW DID WE DO IT?**

By increasing the size of our page; by discarding non-essential data and editing the balance; by listing only those receivers which the Service Engineer will definitely have to repair (no communications or export receivers, no shortwave sets or amplifiers, no electronic devices, etc.); by many months of hard work based on a definite plan of procedure and a clear understanding of the actual requirements of the Service Engineer. There is no "dead weight" information to add bulk to this Manual. Every word counts. Every minute of reading time is well spent.

### OUTSTANDING FEATURES

- Contains data on more than 1800 receiver models!—more than any other radio service manual.
- Only 736 pages!—less than half the bulk of any other manual and more than 1/3 lighter.
- All information is EDITED!—all non-essential data deleted and the balance checked and correlated with the schematics and sketches.
- 40% larger page permits listing of all information on one page. (A few unavoidable cases excepted.)
- I.F. peaks for all superhet circuits are boldly displayed in black boxes—none missing, all accurate.
- No space wasted on communications and export receivers, amplifiers, electronic musical instruments, etc.—a 100% Service Engineer's Manual.

### A "CUSTOM-TAILORED" MANUAL FOR SERVICE ENGINEERS

Here, at last, is a Service Manual deliberately PLANNED for the Service Engineer. Instead of a mere hodge-podge collection of service data, as manuals have been in the past, this RADIO CIRCUIT MANUAL is an orderly compilation of essential radio diagrams and service information, carefully edited and uniformly presented for the maximum convenience of the busy Service Engineer. All time-consuming, non-essential data have been weeded out, and the remaining information, vitally important to the rapid and efficient servicing of modern radio receivers, has been laid out in a logical, easy-reading style which cuts time from the day's work. Because of this and other features which are self-evident upon first observation, it has been possible to list all information pertaining to a given model on a single page.

In 736 pages this Manual presents essential service data on over 1800 receiver models;—more than any other existing service manual on the market!

### ONLY ONE MANUAL PER YEAR!

The new technique used in compiling this RADIO CIRCUIT MANUAL—1941 makes it possible to include in a single book all the new receiver models which the radio industry can produce in a single year. This factor alone represents an important saving to all Service Engineers.



← THE OLD TYPE MANUALS—Bulky, heavy, hard to handle, space consuming, less USEFUL data despite greater number of pages.



OUR NEW MANUAL—Lighter, compact, easy to handle, takes half as much room on the shelf, more USEFUL information despite fewer number of pages. →

### MANUALS NOW READY!

RADCRAFT PUBLICATIONS, INC.,  
25 West Broadway, New York, N. Y.

Gentlemen: Enclosed find my remittance of \$10.00, for which send me, POSTPAID, my copy of the RADIO CIRCUIT MANUAL—1941.

PLEASE PRINT CLEARLY

Name .....

Address .....

City .....

State .....

RC-1-43

(Send remittance in form of check or money order; register your letter if you send cash.)

### ORDER YOUR MANUAL IMMEDIATELY — NOW!

Get your copy directly from us by filling out and mailing the convenient coupon shown at left, or get it directly from your favorite distributor.

736 pages; size 13 1/2 x 10 1/4 x 2 in. thick; loose leaf, leatheroid-covered stiff binder; net weight 6 1/2 lbs.

ONLY  
**1000**

### A PERMANENT INSTITUTION

This Radio Circuit Manual—1941 is NOT a one-time proposition. Next year there will be a Radio Circuit Manual—1942, the following year, 1943 and so on indefinitely—each Manual better than the other as new methods are worked out for expediting and simplifying the work of the practicing Service Engineer.

**RADCRAFT PUBLICATIONS, INC.**  
**25 WEST BROADWAY NEW YORK, N. Y.**



# Lowest Priced Publications for Experimenters

**10 FOR 50c**

Here is a large number of radio, short-wave, and mechanical "how-to-make-it" designs.  
Each is a special publication originated by masters in their respective fields.  
For the low price of 50 CENTS, you buy TEN complete pamphlets with photographic reproductions, complete mechanical layout, and full description to make it possible for anyone to build the project in question.

PLEASE ORDER EACH PROJECT BY ITS PUBLICATION NUMBER, and use the special coupon below.  
We accept money-orders, cash, checks or new U. S. stamps. (No foreign stamps.) If you send cash or stamps, register your letter.  
Money refunded if you are not satisfied.  
**ANY TWENTY-FOUR PUBLICATIONS FOR ONE DOLLAR.**

## SHORT-WAVE RECEIVER PUBLICATIONS

- HOW TO MAKE THE "OSCILLODYNE" 1 TUBE WONDER SET.....No. 101
- HOW TO MAKE THE "19" TWIN- PLEX (ONE TUBE PERFORMS AS TWO) RECEIVER.....No. 102
- HOW TO MAKE THE WIZARD- 1- TUBE 50-WATT TRANSMITTER.....No. 103
- HOW TO MAKE THE IMPROVED 3-TUBE DOERLE SET FOR BATTERY OPERATION.....No. 104
- HOW TO MAKE THE "GO-GET- EM '2" RECEIVER FOR THE BEGINNER.....No. 105
- HOW TO MAKE THE 1-TUBE ALL-ELECTRIC OSCILLODYNE.....No. 106
- HOW TO MAKE THE 2 TO 5 METER TWO-TUBE LOUDSPEAKER SET.....No. 107
- HOW TO MAKE THE 3-TUBE BATTERY SHORT-WAVE RECEIVER.....No. 108
- THE BRIEF-CASE SHORT-WAVE RECEIVER AND HOW TO BUILD IT.....No. 109
- HOW TO BUILD THE POCKET SHORT-WAVE RECEIVER.....No. 110
- HOW TO BUILD THE CIGAR- BOX 1-TUBE "CATCH ALL" RECEIVER.....No. 111
- HOW TO BUILD THE "DUAL-WAVE" SHORT-WAVE BATTERY RECEIVER.....No. 112
- HOW TO BUILD THE 1-TUBE "53" TWINPLEX" RECEIVER.....No. 113
- HOW TO BUILD THE PORTABLE MINIDYNE SHORT-WAVE BATTERY SET.....No. 114
- HOW TO BUILD THE HAM-BAND "PEE-WEE" 2-TUBER.....No. 115
- HOW TO BUILD THE DUO-AMPLIDYNE.....No. 116
- HOW TO BUILD THE "MONO-COIL 2".....No. 117

## RADIO BROADCAST RECEIVER AND SPECIAL RADIO PUBLICATIONS

- HOW TO MAKE THE A.C.-D.C. "CASH BOX" RECEIVER No. 118
- HOW TO MAKE BEGINNER'S 2-TUBE ALL-WAVE SET.....No. 119
- HOW TO BUILD THE "RADIO-LAMP" 4-TUBE TABLE RECEIVER.....No. 120
- HOW TO BUILD A SUPER-SENSITIVE ALL-WAVE CRYSTAL SET.....No. 121
- HOW TO BUILD THE 2-TUBE "PENTODE PORTABLE" BROADCAST SET.....No. 122
- HOW TO BUILD THE RADIO "TREASURE" FINDER.....No. 123
- HOW TO BUILD THE GERNSBACK ONE-TUBE PENTODE LOUDSPEAKER SET.....No. 124
- HOW TO BUILD THE WORLD'S SMALLEST ONE TUBE BATTERY RADIO.....No. 125
- HOW TO BUILD A 6-TUBE BATTERY ALL-WAVE "FARM PORTABLE" SET.....No. 126
- HOW TO MAKE AN A.-D.C. ONE-TUBE "DEAF AID".....No. 127
- HOW TO BUILD A PIANOTRON.....No. 128
- HOW TO BUILD THE ONE-DOLLAR RADIO.....No. 129
- HOW TO MAKE A VARIABLE-TONE CODE PRACTICE SET.....No. 130

## MECHANICAL PROJECTS PUBLICATIONS

- HOW TO MAKE A SOUTH SEA OUTRIGGER CANOE.....No. 131
- HOW TO BUILD A PEE-WEE AUTOMOBILE.....No. 132
- HOW TO BUILD A DUAL-CONTROL GLIDER.....No. 133
- HOW TO BUILD A HOUSEBOAT ON PONTOONS.....No. 134
- HOW TO MAKE A BAND SAW FROM OLD AUTO PARTS.....No. 135
- HOW TO BUILD A REAL LATHE FOR \$5.00.....No. 136
- HOW TO BUILD A SAIL CATBOAT.....No. 137
- HOW TO BUILD A SIMPLE PORTABLE REFRIGERATOR.....No. 138
- HOW TO BUILD A XYLOPHONE.....No. 139
- HOW TO BUILD THE ROWMOBILE.....No. 140
- HOW TO BUILD LARGE TESLA AND OUDIN COILS GIVING 18-INCH SPARKS.....No. 141
- HOW TO MAKE AN ARC WELDER.....No. 142
- HOW TO USE AN A.C. ARC WELDER.....No. 143
- HOW TO MAKE YOUR OWN MICROSCOPE.....No. 144
- HOW TO MAKE A WIMSHURST ELECTROSTATIC MACHINE.....No. 145
- HOW TO MAKE A POWER DRILL PRESS FROM SCRAP PARTS.....No. 146
- HOW TO BUILD A GOOD LATHE FOR \$1.00.....No. 147
- HOW TO MAKE AND EXPERIMENT WITH AN ELECTROPHOROUS.....No. 148
- HOW TO MAKE AN ELECTRIC ARC WELDER FROM AN AUTOMOBILE GENERATOR.....No. 149

## RADIO PUBLICATIONS, 25 West Broadway, NEW YORK, N. Y. RC 1

I enclose \$.....for the publications listed by number, at right, at the rate of 50c FOR ANY TEN PUBLICATIONS. NO ORDER FOR LESS THAN 50c ACCEPTED. \$1.00 for 24 publications. These publications are to be sent to me PostPaid. I have placed a circle around each number which I want.	101	102	103	104	105	106
PLEASE PRINT CLEARLY	107	108	109	110	111	112
Name .....	113	114	115	116	117	118
Address .....	119	120	121	122	123	124
City .....	125	126	127	128	129	130
State .....	131	132	133	134	135	136
	137	138	139	140	141	142
	143	144	145	146	147	148
						149

## 10 BEST RADIO BOOKS 10 CENTS EACH

- RADIO FANS EVERYWHERE—these fine cent text books give you an excellent foundation for the study of RADIO. They are clearly written, profusely illustrated and contain over 15,000 words in each book. You'll be amazed at the wealth of information contained in these handy books. Excellent for reference—ideal for every technical library. **YOUR MONEY BACK** if you are not satisfied. **PROMPT SHIPMENTS**
- No. 1—HOW TO BUILD FOUR DOERLE SHORT WAVE SETS
  - No. 2—HOW TO MAKE THE MOST POPULAR ALL-WAVE AND 2-TUBE RECEIVERS
  - No. 3—ALTERNATING CURRENT FOR BEGINNERS
  - No. 4—ALL ABOUT AERIALS
  - No. 5—BEGINNERS' RADIO DICTIONARY
  - No. 6—HOW TO HAVE FUN WITH RADIO
  - No. 7—HOW TO READ RADIO DIAGRAMS
  - No. 8—RADIO FOR BEGINNERS
  - No. 9—SIMPLE ELECTRICAL EXPERIMENTS
  - No. 10—TELEVISION

### BOOKS ARE ALL UNIFORM

Every book in the GERNSBACK EDUCATIONAL LIBRARY has 32 pages—with illustrations varying from 30 to 66 in number. Each title volume contains over 15,000 words. Positively, radio's greatest book buys! If you do not think these books worth the price asked, return them in 24 hours and your money will be instantly refunded.

## RADIO PUBLICATIONS • 25 WEST BROADWAY • NEW YORK, N. Y.

RADIO PUBLICATIONS, Dept. RC-1-43  
25 WEST BROADWAY, NEW YORK, N. Y.

Gentlemen: Please send immediately, POSTPAID, the book numbers circled below. I am enclosing ..... cents—each book being 10c.

1    2    3    4    5    6    7    8    9    10  
NEW NEW

Send FRED listing of 48 new 10c publications.  
PLEASE PRINT CLEARLY

Name ..... Address .....

City ..... State .....

Remit by check or money order—register letter if you send cash or unused U. S. postage stamps.

**MAIL COUPON TODAY!**

## WHAT IS AHEAD IN ELECTRONICS?

(Continued from page 203)

now, in exactly the same manner following the same pattern, the electron tube, conceived wholly for wireless communication, has already entered the doors of a thousand industries. Its future lies perhaps more grandly in its industrial applications than it does with broad spreading of the human voice, faces, music, and intellectual intercourse generally. Already steel makers control their Bessemer with its aid and with unerring accuracy. Huge panels of plywood and plastic board are cemented together under hydraulic pressure and dried in a tith of the time formerly demanded. The high-frequency bombardier is already a recognized factor in welding, soldering, melting, brazing, case-hardening operations, doing a quicker, neater job than the time-honored methods could ever perform. Tomorrow it will displace ten thousand furnaces. A self-balancing recording equipment registers data faster than 3 or more men with pads and pencils, and with infallible accuracy. The electron tube has already matriculated into higher mathematics, solving quickly intricate formulae.

Photo-cell and amplifier indicate combination efficiency by measuring density of smoke to one-half of one per cent CO<sub>2</sub> variation, record it, and then automatically control the firing stokers.

The ubiquitous electron tube measures the thickness of ice forming on a plane's wings, and at the critical moment operates the de-icers. In the Police Court a lie detector, tube-operated, points the guilty finger where detective and psychiatrist stand baffled. In the refinery, the varnish factory, where high volatiles or explosives are concocted, the approach of the flash point, or danger heat is quietly announced, in ample time to avoid catastrophe.

In the hospital, and home as well, short-wave diathermy and improved galvanic devices are today proving their irreplaceable value, not only as healers, but as preventatives of a host of dangerous ailments or mal-adjustments. This field of application, scarcely 10 years old, marks only the threshold of a vast new medical science, where the old adage, "Electricity Is Life," will indeed demonstrate its fundamental truth.

These, and a thousand other applications of Electronics to mankind's needs, comfort, and to the fulfillment of the "abundant life"—all as yet undreamed of—will characterize this Twentieth, as "The Electronic Century."

## HANDY RADIO DATA BOOK

Every once in a while someone gets up a handbook or a data book that hits the bull's-eye so far as utility is concerned.

Such a job has been done by Allied Radio Corporation of Chicago, in their new *Radio-Formula and Data Book*.

In forty pages and 5 diagrams, with numerous charts and tables, it covers algebraic formulae; the more common electrical formulae; vacuum tube work; meters; wire tables; trigonometry; metric conversion; color codes for resistors, condensers, transformer and speaker leads, logarithms, decibel tables, symbols and abbreviations, decimal equivalents and even the Greek alphabet.

It's a handy little booklet and ought to find thousand of users. It's worth the slight charge asked for it.



**SERVICING NOTES**

*Trouble in . . . . .*  
 . . . . . ZENITH 85463

Squeal when volume control is beyond middle position is normally due to open 16 mfd. condenser No. C23 and not due to the volume control being worn.

LAURENCE ROESHOOT,  
 Wilkes-Barre, Pa.

**ATTENTION SERVICEMEN!**

Do you have any Servicing Notes available which you would like to bring to the attention of the readers of *Radio-Craft*? If so, send them along and earn a one year's subscription to *Radio-Craft* for each one submitted.

. . . . . SPARTON MODEL NO. 567

This model uses two pilot lights of the screw type base. The pilot light socket was found pushed against, or touching, the metal that holds the receptacle in place behind the dial, causing a short of the 6.3 volt winding. Clearing the pilot light allows all tubes to light and the set to play OK.

. . . . . ALL ZENITH MODELS USING A TWO-SECTION CANDOHM RESISTOR OF 40-200 OHMS

Replacements hard to obtain. Usually the 40-ohm section is bad. Shunt it with a "Zipohm," or other wire-wound resistor of proper ohmage.

HERBERT NOONES,  
 East St. Louis, Ill.

. . . . . PHILCO 1942 RECORD CHANGERS

Rasping noise as motor is running is caused by bell drive shaft hitting frame at base. Some holes were found off center in respect with bearing. Reversing bearing clears up trouble.

LEONARD CHIOMA,  
 Waterbury, Conn.

**KINKS**

(Continued from page 250)

excess heat and the iron will be less likely to overheat and (2) the heat absorbed by the condenser plates will be radiated because of the large surface area.

In consequence, the holder will not harm your table or bench. The more plates in the unit, the cooler it will be.

GAYLORD ST. THOMAS  
 St. Paul, Minn.

**MIKE AND PICKUP INPUT**

A crystal and orthophonic phonograph pickup head is all that is needed for an im-

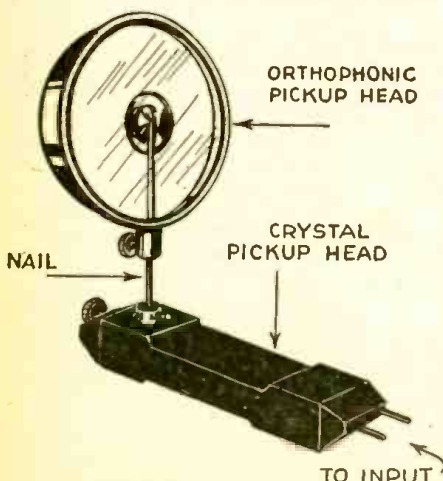

RADIO AMATEUR COURSE

# RADIO AMATEUR COURSE

By G.W. Shuart "W2AMN"

## RADIO & TELEVISION

PRICE 50¢

---

**148 PAGES**  
6 x 9 INCHES

**OVER 150 RADIO DIAGRAMS**  
and TECHNICAL PHOTOGRAPHS

**RADIO AND TELEVISION**  
25 West Broadway New York, N. Y.

**Your Money Back —**

If the RADIO AMATEUR COURSE does not represent the greatest book value ever offered to the radio "fans" for **50c**

To convince you that there isn't a better book buy today, the publishers of the RADIO AMATEUR COURSE make the sensational offer of a money-back guarantee on such a low-priced book. Stop in at any of the many dealers handling this book and examine it. See for yourself if the RADIO AMATEUR COURSE isn't just the book you've always wanted.

Printed on the finest coated paper —well illustrated attractive 4-color cover—complete with radio information you must have. It contains a step-by-step program for obtaining a short-wave radio education.

Written by George W. Shuart,  
 W2AMN  
 foremost short-wave authority

**RADIO AND TELEVISION**  
 25 West Broadway, New York, N. Y.

Gentlemen: I enclose herewith my remittance of Fifty Cents (50c) for which please send me POST-PAID, my copy of the RADIO AMATEUR COURSE. (Remit by check or money order; register letter if you send cash or unused U. S. postage stamps.) PLEASE PRINT CLEARLY

Name .....

Address .....

City ..... State ..... RC-1-43

provised mike.

You simply extend a nail, with head cut off, from one needle socket to the other.

The output of the crystal is wired to the input of the amplifier or whatever you have on hand.

The speech goes into the orthophonic head, from there the vibrations go to the crystal head making a perfect crystal mike.

For certain experiments a lot of fun can be had; and in others some interesting observations made.

S. RUSTYAK,  
 Ithaca, N. Y.

**UNUSUAL COIL WINDING ARRANGEMENT**

I have been using reclaimed wire from

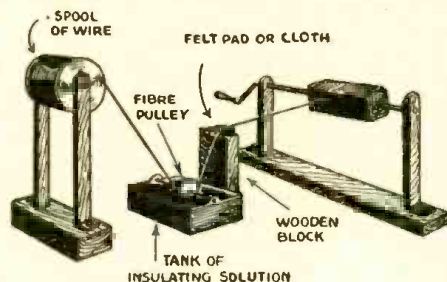

small audio transformers, filter chokes, and speaker fields, which has a paraffin wax coating, instead of shellac or enamel.

The diagram shows how I used the wire, passing it through a tray of insulating compound before winding onto the form.

Perhaps many of the radio fraternity can use this idea.

JAMES CALLAN,  
 Hamilton, Ont., Canada.



**"THE INDUCTANCE AUTHORITY"**

By EDWARD M. SHIEPE, B.S., M.E.E.  
 1A NEW BOOK!

THE ONLY BOOK OF ITS KIND IN THE WORLD. "The Inductance Authority" entirely dispenses with any and all computation for the construction of solenoid coils for tuning with variable or fixed condensers of any capacity, covering from ultra frequencies to the borderline of audio frequencies. All one has to do is to read the charts. Accuracy to 1 per cent may be attained. It is the first time that any system dispensing with calculations and correction factors has been presented.

There are thirty-eight charts, of which thirty-six cover the numbers of turns and inductive results for the various wire sizes used in commercial practice (Nos. 14 to 32), as well as the different types of covering (single silk, cotton-double silk, double cotton and enamel) and diameters of 3/8, 7/8, 1, 1 1/4, 1 1/2, 1 3/4, 2, 2 1/4, 2 1/2, 2 3/4 and 3 inches.

Each turns chart for a given wire has a separate curve for each of the thirteen form diameters.

The book contains all the necessary information to give the final word on coil construction to service men engaged in replacement work, home experimenters, short-wave enthusiasts, amateurs, engineers, teachers, students, etc.

There are ten pages of textual discussion by Mr. Shiepe, graduate of the Massachusetts Institute of Technology and of the Polytechnic Institute of Brooklyn, in which the considerations for accuracy in attaining inductive values are set forth.

The book has a flexible fiber black cover, the page size is 9 x 12 inches and the legibility of all curves (black lines on white field) is excellent.

Price at your dealer or direct—\$2.50

**GOLD SHIELD PRODUCTS**

350 Greenwich St., (Dept. R.C.1), New York City



# TECHNICAL BULLETINS

Technical bulletins give reliable information in easy-to-follow form, and save valuable time otherwise spent in laborious reading of numerous books. Every subject is treated briefly and concisely, yet completely. No complicated mathematics, chemistry, electricity, or theory. Each bulletin is written in simple language.

PRICE \$1.00 EACH POSTPAID  
ORDER BY NUMBER

## WELDING, SOLDERING AND BRAZING

**D-105—LATEST GAS-WELDING PRACTICE.**—Contains simplified instructions for using the modern oxyacetylene torch for welding and cutting. Includes instructions for welding steel, cast iron, aluminum and aluminum alloys, lead and lead alloys, nickel and nickel alloys, monel metal, etc. Contains data on lead burning, gas pressure for all jobs, formulas for fluxes.

**D-133—SPOT WELDER FOR THE SMALL SHOP.**—Complete, easy-to-understand directions to build a 110-volt, 50 or 60-cycle A.C. spot welder for fastening light sheet metal. Shows how to make the welder adaptable for operation on 110 or 220-volt, 25-cycle current, or 220-volt, 50 or 60-cycle current.

**D-136—SMALL A.C. ARC WELDER CONSTRUCTION AND USE.**—Tells how to build arc welders capable of fusing iron and steel sheet up to 3/16 inch in thickness and rods as large as 1/2 inch in diameter for use on 110-volt, 60-cycle A.C., 110-volt 25-cycle A.C., or on 220-volt 60 cycle A.C.

**D-135—WELDING SHEET METAL WITH EASILY MADE ELECTRIC ARC TORCH.**—A small carbon-electrode arc torch that operates on 110-volt A.C. current. Of value to metal-working shops and home work shops for soldering and brazing, and even light welding on sheet metal. Can also be used to melt small quantities of metals and alloys. Also used by Dentists to melt gold.

**D-122—WORKING WITH STAINLESS STEEL. SOLDERING, BRAZING, AND WELDING.**—Complete practical methods of soldering, brazing and welding stainless steel, including formulas for solders and fluxes and other practical data.

**D-124—SOLDERING ALL METALS, INCLUDING ALUMINUM, AND ALLOYS AND DIE CAST ALLOYS.**—How to produce perfectly soldered joints of neat appearance. Identification of light metal alloys. Solders and soldering fluxes and how to make them. How to make electric soldering irons for light and heavy work, how to construct an alcohol blowpipe.

**D-104—SILVER SOLDERING AND BRAZING.**—Explains practical methods of brazing, silver soldering, and hard soldering. Contains tables giving the composition of brazing and soldering alloys, formulas for fluxes.

**D-141—RECORDING THERMOMETER EASILY MADE.**—Full information on building an accurate device to record temperature changes over 12 hour periods. Uses any type of clock and a sensitive element carrying a pen that marks temperature fluctuations on a paper chart.

Each Bulletin consists of a set of large sheets, assembled in one packet, size 9 x 14 1/2"; weight 1/2 lb. Numerous illustrations, diagrams, charts to supplement text.

## TECHNIFAX

1017 S. STATE ST. RC143 CHICAGO, ILL.

RC143

**TECHNIFAX** 1017 So. State, Chicago, Ill.

Enclosed find \$..... for which please send me postpaid the following Technical Bulletins:

No. ....

Name .....

Street and Number .....

City and State .....

## WATTAGE AND CURRENT RELATIONS IN RESISTORS

THE selection of a resistor for a specific application requires a knowledge of not only the resistance required but also the wattage to be dissipated, as the physical size of the resistor will be largely determined by the latter factor. Another point of importance is the degree of ventilation, as the nominal wattage ratings are based on free air mounting of the resistor.

The wattage to be dissipated in the resistor can be calculated readily by means of Ohm's Law when the resistance and current (or voltage directly across the resistance) are known. It is important to note that the wattage dissipated in a resistor varies as the square of the current, as stated in the equation:  $W = I^2R$

$W$  = Watts  
 $I$  = Current in amperes  
 $R$  = Resistance in ohms

Non-technically stated this means that any change in the current causes a much greater change in the wattage, as graphically illustrated above. Thus, if the current is doubled, the wattage is multiplied by  $(2)^2$  or 4; if the current is tripled, the wattage is multiplied by  $(3)^2$  or 9. The importance of small changes in current is often over-looked, but it should be realized that if the current is increased by only 10%, the wattage is increased by 21%; and if the

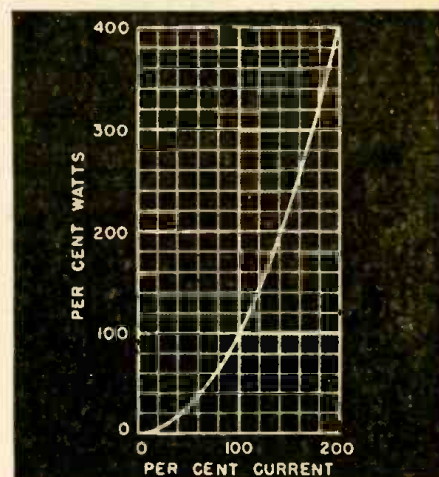

This graph enables one to quickly find the percentage of increase in wattage, for a corresponding increase of current.

current is increased by 20%; the wattage is increased by 44%. Hence, the actual current must be used in figuring the wattage, and the increase in wattage due to apparently small changes determined, in order to select the proper size resistor.—*Ohmite News.*

## ELECTRONIC COP

(Continued from page 208)

extinguishes itself. The complete equipment then resets for the next car.

Regarding the possibility of more than one car passing through the section, the sequence would work out something like this:

Suppose two cars, A and B, one following the other, say within 50 feet, are in the section. Car B overtakes car A and passes the final beam before car A does.

The timer is started by the first car which intercepts the initial beam (car A), and seal-ins the circuit. Since car B cuts

the final beam first, the sign flashes the speed as the timer "saw" it, and the cutting of the final beam by car A has no effect.

In other words, the sign flashes virtually the "meshed" speeds of cars A and B. And so it would be also for four, ten or 20 cars; the timer would be sealed-in by the first car, but would flash the meshed speed.

The extreme case would be a car travelling very very slowly, cutting the first beam, and then just a split second before cutting the second beam, a faster vehicle passes it and cuts the beam. In this case the beams were cut by two cars of extreme speeds, but the timer records the speed of virtually one car.

## FM BROADCASTING SUPERIOR SURVEY REVEALS

IN an effort to learn what the public thinks of FM broadcasting, General Electric engaged an independent research organization to make a survey in New York and other large cities.

During the hundreds of interviews, no mention of any manufacturer was made.

Names of FM set-owners were obtained from dealers in each of the 14 cities covered.

Results of the survey follow:

Seventy-nine per cent of those interviewed are satisfied with the FM quality of reception.

Eighty-five per cent believe FM quality a decided improvement over regular broadcasts.

Seventy-five per cent tune in on FM stations more than once a week, over 50 per cent listen to FM at least once a day.

Ninety-one per cent would recommend a set equipped with FM to their friends.

Forty-five per cent believe that "improved tone quality" is the one FM advantage more important to them; 41 per cent think "freedom from noise and static" is the most important advantage.

Seventy-nine per cent said "yes" to the question, "Have any of your friends listened to FM on your radio?"

Ninety per cent said their friends' opinions of FM radio are, "Favorable."

## JAMPROOF RADIO TRANSMISSION

FRANCOIS CHARLES PIERRE HENROTEAU of Ottawa, Canada, has invented a new method of sending secret radio messages which cannot be "jammed."

As is well known, almost any frequency (except the ultra highs) can be jammed so that only howls and whistles emanate from the receiver.

The ultra highs of course are not so easily affected because of their short range.

Henroteau's means of foiling the jam and still holding to secret transmissions is to use a plate, called a key plate, which distorts the frequency of the wave, as patterned on the plate.

A similar key plate is used at the receiving end and cancels the distortion portion.

Should the enemy discover the pattern of the plate being used, a different plate may be used.

What prevents the enemy from jamming the desired signal is that he would have to vary his signal in exactly the same manner.

Thus he would be kept pretty busy trying to trace the pattern, and even if he found it, he would soon find a new one on his hands to contend with.



# BOOK REVIEWS

**MICROWAVE TRANSMISSION**, by J. C. Slater, published by McGraw-Hill Book Company, Inc. Stiff covers, size 5 x 9 inches, 309 pages. Price \$3.50.

The author states in the preface that by microwaves is meant those electromagnetic waves whose lengths lie in the one to one hundred centimeter region.

To the uninitiated it might be explained that these are the signals which are sent through hollow conductors or through coaxial lines. Such means of transmission is imperative, for the great amount of radiation that would occur in ordinary parallel lines would be disastrous.

Microwaves of course are modern, in the sense that investigation and experimentation has been recent. What literature that has appeared heretofore has been only in the technical journals. The author combines all verified and accepted data in the art, and presents it with extreme clarity to the engineer and advanced student.

The accepted theory of transmission lines in communications has been carried over into the study of microwaves, but with the additional notion that more attention must be given the electromagnetic field. It is for this reason that Maxwell's equations are injected sufficiently to establish sound workable theory.

Descriptions of practical methods of utilizing the fundamental principles outlined are given.

With the idea that a communications system consists of a power source, a transmission line, and a receiver, the author concentrates on the transmission line, as it is this part of the system that is new and needs modern exposition.

However, radiation from antennae, directive devices for antennae, and coupling of coaxial lines and wave guides, are also covered.

For the man interested in this new branch of the radio and communications field, this should prove a valuable and often used guide.

**THE RADIO AMATEUR'S HANDBOOK**—1943 Edition. Published by the American Radio Relay League, Inc. Flexible paper covers, size 6½ x 9½ ins. 478 pages. Price \$1.

This new edition is exceptionally well-fitted for its wartime rôle. Not only does it continue the long record of comprehensive and authoritative coverage of its sphere, but added new material on civilian-defense communications makes its usefulness universal. It is the twentieth and largest edition.

The *Handbook* is now the recognized training text, valuable in teaching radio for military and civilian purposes in efficient and practical fashion.

The simple treatment of fundamentals is retained, and the theory and design sections are neatly indexed and cross-referenced.

The chapter on WERS constitutes a manual on this subject, including as it does, regulations, operating, organization and equipment data.

The 700 illustrations and 100-odd charts and tables are of inestimable value.

And the list of vacuum tubes, both transmitter and receiver type is not found elsewhere.

This work should be in everyone's hands.

**SCIENCE REMAKES OUR WORLD**, by James Stokley. Published by Ives Washburn. Stiff cloth covers, size 6 x 9 inches, 298 pages, 40 illustrations. Price \$3.50.

Those of us interested in radio, television, photography, chemistry or just plain "experimenting," remember the enthusiasm and joy with which we read works on everyday science which did not bewilder us with mathematics or technical jargon, or long-winded dry descriptions; but which on the contrary seemed to "talk" to us in an easy informal and informative style.

Such a book, in 1942, is this one.

It covers every field of modern science from explosives to plastics; fuels, rubber, chemical therapy, vitamins and metals.

The ocean itself is an untouched world which will yield its riches when processes now experimental, are worked commercially.

The new world in glass—which will touch every phase of our life—will be something beyond ordinary comprehension today.

There is nothing in this book which would not appeal to the engineer, the physicist, the home experimenter, and the well-informed executive, as well as it does to the keen-eyed eager youngster who is trying to comprehend the complex world about him, and to whom the endless array of modern science is a fascination to him beyond all else.

Do you want to know what the answers are to the questions, "What is an atom?", "What is an electron?" You will find the answers here. Answers that certainly enable you to understand and talk science that is 1942.

In our opinion, this is a book that should be in every library, public or private. It is a major work in its field.

## REPLACEMENT STOCKS AMPLE

**ALTHOUGH** much has been said about shortages of replacement parts—tubes, volume controls, condensers, etc., it seems that this is not always so.

The explanation seems to be that one repairman or dealer has run out of certain items and has not restocked (owing to priority difficulties of course), while another's stock is not depleted, or has been kept up, and certain common parts are available.

Also, through the WPB, there has come into the picture, what is called the "victory" list of parts for home radios, which is a big step toward simplification and standardization.

We are all familiar with the long list of volume controls for every type of set, running into thousands. On the victory list, it will be about 50 types. Likewise some 400 various types of condensers will be reduced to a list of about 11, for replacement purposes.

Transformers and chokes also, some 200 varieties, will be represented by 24 replacement types.

Altogether this is a wholesome picture and very encouraging, for it will mean easier replacing, fewer parts (that are better and cheaper than so many that are special for each manufacturer and therefore a little more expensive), and less worry about getting exact components.

## GROUND PILOTS

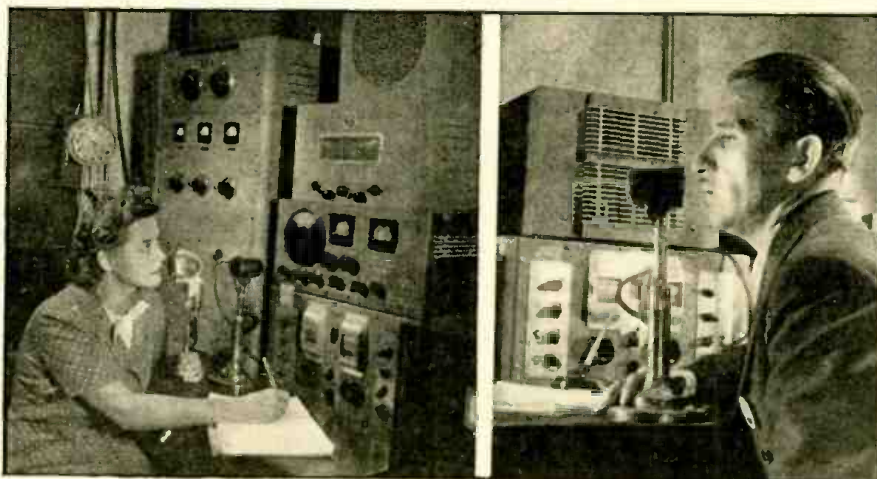

Radio checks flight at Bell Aircraft.

**THE** photos show (left) Miss Ruby Becker logging a flight traffic check and test of a Bell Aircraft *Airacobra*, while (right) foreman Harold Brundige gives a "quality check" to another *Cobra* in flight.

Many of these tests are handled by Miss Becker, who decided that this kind of work is more fun than teaching. She possesses a restricted radio telephone operator's license.

For three years she trained for a teach-

ing career, then suddenly decided that radio offers better opportunities. Shortly after she took a course in the Fundamentals of Radio Technology. Upon completing the course she passed the Federal Communications Commission tests and was prepared for her present job. The Bell Radio control room, besides maintaining ground-to-plane contacts is used to test every radio in every *Cobra*.



# FM FUNDAMENTALS AND PRACTICES

given in this new book

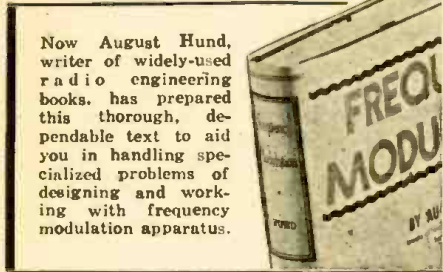

Now August Hund, writer of widely-used radio engineering books, has prepared this thorough, dependable text to aid you in handling specialized problems of designing and working with frequency modulation apparatus.

## JUST OUT! — HUND'S FREQUENCY MODULATION

375 pages, 6x9, 113 illustrations, \$4.00

This is an engineering treatment of frequency modulation, covering both basic principles and the design of commercial apparatus. The phenomena and features of frequency and phase modulation are described in a thorough approach that includes comparison with customary amplitude modulation, following which applications in FM transmitters, receivers, auxiliary apparatus, and antennas are fully discussed. The use of tables and curves to simplify design is emphasized.

### This New Book Gives

- information to help in employing special design formulas in connection with band width characteristics of networks.
- methods of testing, useful both in designing and maintaining FM receivers.
- many explanations directly in the illustrations.
- etc.

### 10 DAYS' FREE EXAMINATION

McGraw-Hill Book Co., 330 W. 42nd St., N. Y. C.  
Send me Hund's Frequency Modulation for 10 days' examination on approval. In 10 days I will send you \$4.00 plus few cents postage or return book postpaid. (Postage paid on cash orders.)

Name .....

Address .....

City and State .....

Position .....

Company ..... RC 1-43

# MATHEMATICS FOR RADIO

Two volumes, prepared for home study. Book I (314 pp.) covers the algebra, arithmetic, and geometry; Book II (329 pp.) covers the advanced algebra, trigonometry, and complex numbers necessary to read technical books and articles on radio.

MAEDEL PUBLISHING HOUSE Room 102  
593 East 38 Street, Brooklyn, New York

Send me MATHEMATICS FOR RADIO AND COMMUNICATION as checked below. I enclose payment therefor with the understanding that I may return the book(s) within 5 days in good condition and my money will be refunded.

Name .....

Address .....

- Book I at \$3.75 plus 6c postage
  - Book II at \$4.00 plus 6c postage
  - Books I and II at \$7.75 postage prepaid
- Foreign and Canadian prices 25c per volume higher

## 1-TUBE INTERPHONE ON A.C.-D.C.

(Continued from page 217)

part which is mounted there. Before the parts are mounted, flaps are bent down in order to form the chassis. The small front panel on which the switches are mounted is fastened to the main chassis with two screws.

The 3-in. P.M. dynamic speaker is mounted on the chassis by 2 small angle brackets.

In wiring the unit there are no special precautions except to note as already mentioned that the "B"-minus return does not ground directly to the chassis.

The cabinet is shown in Fig. 5. The dimensions shown are for the inside of the box. The front panel should be 1/4-in. thick, and the sides may be any thickness desired.

The speaker hole may be the simple circular type shown; or the grill type.

After the units are set up, try reversing the line plug while one station is transmitting to the other. The best position as to minimum hum should be noted and maintained. If the units have been wired up correctly there is almost no chance of trouble.

### LIST OF PARTS

- One Sylvania type 12A7 tube, V (see text re 25A7G);
- One Sprague dual electrolytic condenser, 8 mf., 200 V., C1;
- One Sprague electrolytic condenser, 10mf., 25 V., C2;
- One Cornell-Dubilier paper condenser, 0.1-mf., 200 V., C3;
- One Stancor input transformer, 4 ohms to grid, T1;
- One Stancor universal output transformer, type A-2855, T2;
- One 3-in. permanent-magnet speaker, P.M.;
- One "12A7" type socket;
- One 5-prong socket S1;
- One Centralab D.P.D.T. switch Sw.1;
- One Centralab S. P. S. T. switch, Sw.2;
- One I.R.C. resistor, 2,000 ohms, 1 W., R1;
- One I.R.C. resistor, 1,000 ohms, 1/2-W., R2;
- One resistor, 360 ohms, R3;
- One 5-prong plug, P1, P2;
- One chassis;
- One cabinet.

### Additional Parts for Multi-Station Type

- One Centralab 7-point switch, Sw.3;
- One octal socket, S3;
- One octal plug, P-A to P-G;
- 8-wire rubber-covered cable.

## CORRECTIONS

In the "Simple 2 1/2 Meter Transceiver" appearing on page 754 of the August-September issue the tube marked 558 must be a 958.

In the Economy A.C.-D.C. schematic shown on page 118 of the November issue one of our readers points out that resistors are never measured in microfarads. Therefore he claims the cathode resistor of the first tube should be 300 ohms.

In the article "Square Wave Measurements and Their Future," page 156, December issue, the choke L1 in the 1852 cathode circuit should be omitted; and chokes L3 and L4 in the 6F8 and 6V6 cathode circuits should each have a value of 150 to 500 microhenries, instead of a large value.

## USE THE TUBE MANUAL

(Continued from page 230)

ments or following a diagram, etc.

Then if a man really wants to "dig-in," he will find typical circuit diagrams showing some commercial applications of all the tubes, and a handy list of resistor and condenser values to use with tubes in resistance-coupled amplifiers.

## LAWRENCE SLIDE RULES

With A, B, C, D, C1 and K Scales

FEATURES: Nickel Silver Framed Indicator with integral friction springs. Scales calibrated directly on well seasoned wood. Will retain accuracy regardless of temperature or humidity changes.

Instructions and illustrations of primary operations clearly printed on back of rule for ready reference or teaching. Each rule in a durable pocket carrying case for convenience and protection.



The extremely low price of these slide rules and their absolute accuracy makes them ideal for the student as well as the working man who has always wanted to learn to use a slide rule.

- LAWRENCE 10 inch white-enamelled slide rule with flat magnifier. In black case. Price, including 28-page instruction book No. 457... 60c
- Secret Code Slide Rule, with 20-page book No. 458... 30c (2 for 50c)
- 28-page illustrated book of instructions, postpaid No. 459... 15c

## GOLD SHIELD PRODUCTS

350 Greenwich St. (Dept. RC1) New York City

## Index to advertisers

Aerovox Corporation	197
Allied Radio Corp.	196
Arrow Radio	219
Audel & Co., Theo	Back Cover
Audiograph	245
Candler System Company	227
Cannon Co., C. F.	245
Capitol Radio Engineering, Inc.	197
Chartered Institute of America	245
Commercial Radio Institute	248
Gold Shield Products	253, 256
Hallicrafters, Inc.	Inside Back Cover
Harrison Radio	249
Henry Radio	226
Hudson Specialties Company	242
International Projectionist	248
Lancaster, Allwine & Rommell	245
Lincoln Engineering School	248
Maedel Publishing House	256
Mass. Radio School	245
McGraw-Hill Book Co.	256
Meissner Manufacturing Co.	237
Melville Radio School	227
Midwest Radio Corp.	195
National Radio Institute	193
National Union Corp.	235
Nelson Company	248
N.Y.-YMCA Schools	227
Opportunity Adlets	248
RCA Institutes	227
RCA Laboratories	198
Radcraft Publications, Inc.	241, 247, 251
Radio Publications	252
Radio-Television Institute	227, 253
Radio & Television	240
Radolek Company	217
Readrite Meter Works	196
Silco Publishing Company	244
Solar Manufacturing Company	248
Sprayberry Academy of Radio	219
Supreme Instruments Corp.	245
Supreme Publications	223
Technifax	250, 254
Telex Co.	219
Triplett Electric Instruments Co.	Inside Front Cover
University Laboratories	248

(While every precaution is taken to insure accuracy, we cannot guarantee against the possibility of an occasional change or omission in the preparation of this index.)





# the Sky Buddy was good...but—

THOUSANDS of Hallicrafters Sky Buddies gave faithful service . . . years of excellent performance! Sky Buddy owners will be amazed at how far-reaching the progress of research and new electronic development has been, even in the past year.

When Hallicrafters are again permitted to sell communications receivers for civilian use your new Sky Buddy will have so many improvements, comparison with the old models will be a difficult accomplishment.

Illustration (top) partial view of Hallicrafters Signal Corps communications equipment.

**the hallicrafters co.**

CHICAGO, U. S. A.

keep communications open!

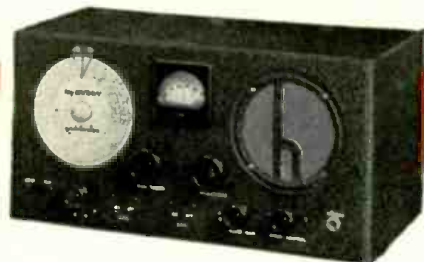



# PRACTICAL RADIO INFORMATION

Including Frequency Modulation—Television, etc.

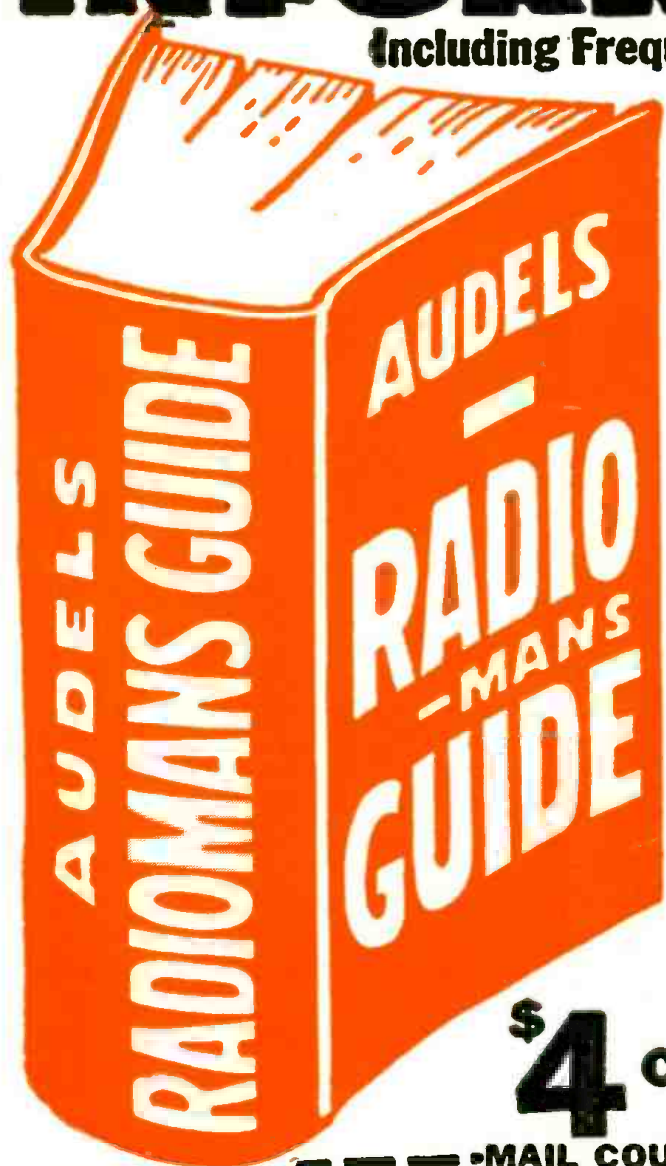

Inside Information for all Servicemen—Aircraft Pilots, Students.

**772 PAGES, 400 DIAGRAMS** is complete—gives Authentic Principles & Practices in Construction, Operation, Service & Repairs. Covers clearly and concisely Radio fundamentals—Ohm's Law—Physics of sound as related to radio science—Measuring instruments—Power supply—Resistors—Inductors—Condensers—Transformers and examples—Broadcasting stations—Radio Telephony—Receivers—Diagrams—Construction—Control systems—Loud speakers—Antennas—Auto Radio—Phonograph pickups—Public Address Systems—Aircraft & Marine Radio—Radio Compass—Beacons—Automatic Radio Alarms—Short Wave—Coil Calculations—Testing—Cathode ray oscillographs—Static Elimination—Trouble Pointers—Underwriter's standards—Units & tables. REVIEW QUESTIONS—Ready Reference Index.

**\$4**

**COMPLETE • PAY \$1 A MO.**

To get this practical information in handy form—Fill in and

— — — — — MAIL COUPON TODAY — — — — —

**AUDEL, Publishers; 49 West 23rd St., New York**  
Mail AUDELS NEW RADIOMAN'S GUIDE for free examination. If O. K. I will send you \$1 in 7 days; then remit \$1 monthly until \$4 is paid. Otherwise I will return it.

Name .....

Address .....

Occupation .....

Reference .....

Please Note:  
If you do not wish to mar this page by clipping coupon—send letter or penny postcard instead.